

Panel/ paneling and door application

SWING DOOR



Types of Applications



Finishes

Primed / Laminated Import

Laminated Suncrest / Matte Lacquer

Wood veneer

What's included

Technical Specifications:

Finish – Designer's choice

Frame – Concealed aluminum

Design – Designers Choice

* Profiles available in Black as on upgrade.

Frame Profiles



In-swing Profile

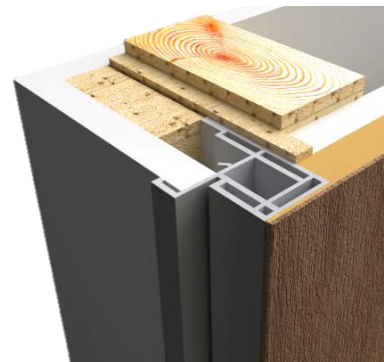

Outswing Profile

Outswing – Inswing Application

* Based on centered doors in the rough opening for inswing/ outswing application

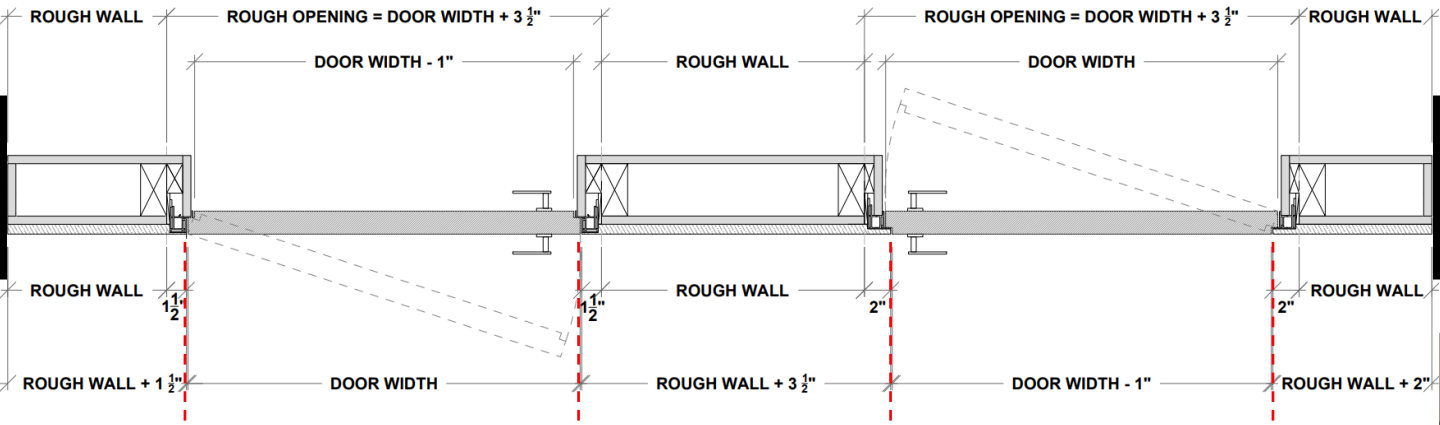

Inswing – Inswing Application

* Based on centered doors in the rough opening for inswing/ outswing application

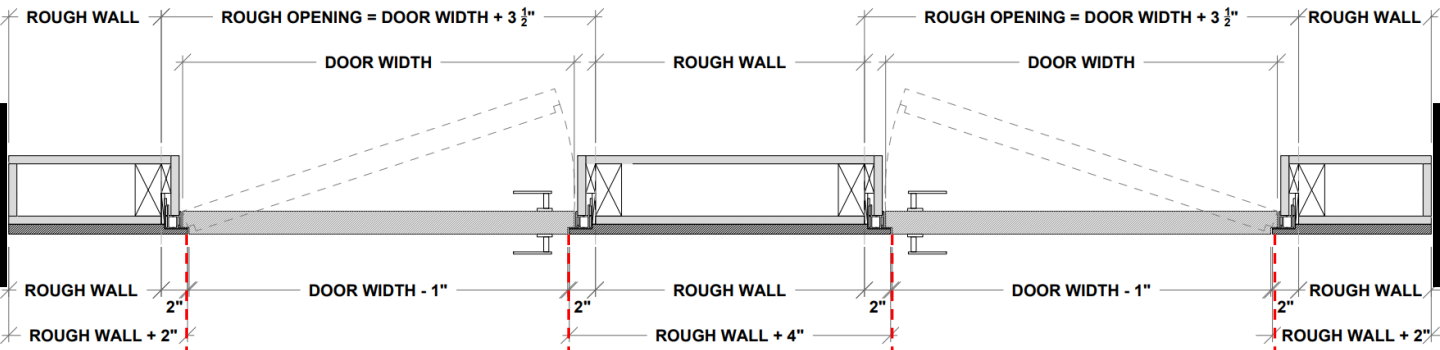

Outswing – Outswing Application

* Based on centered doors in the rough opening for inswing/ outswing application

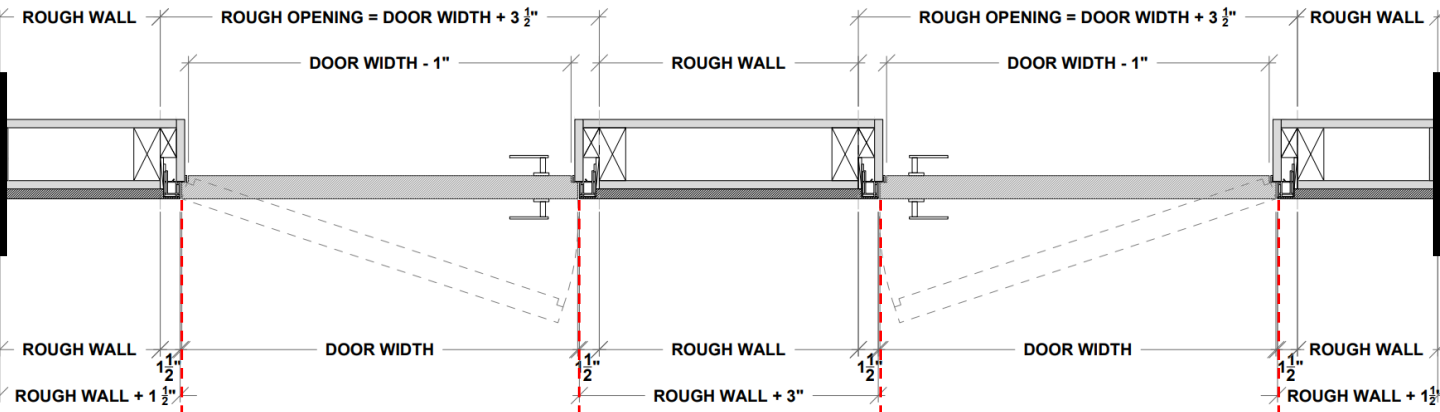

Panel Detail

Outswing Profile

Inswing Profile



Visible Door Height 96"
(True Door Height)

Visible Door Height 95 1/2"
(True Door Height - 1/2")

Panel Detail

Out-swing Profile

Panel Wall

Outswing Profile

Routed Edges

Visible Door Height =
True Door Height

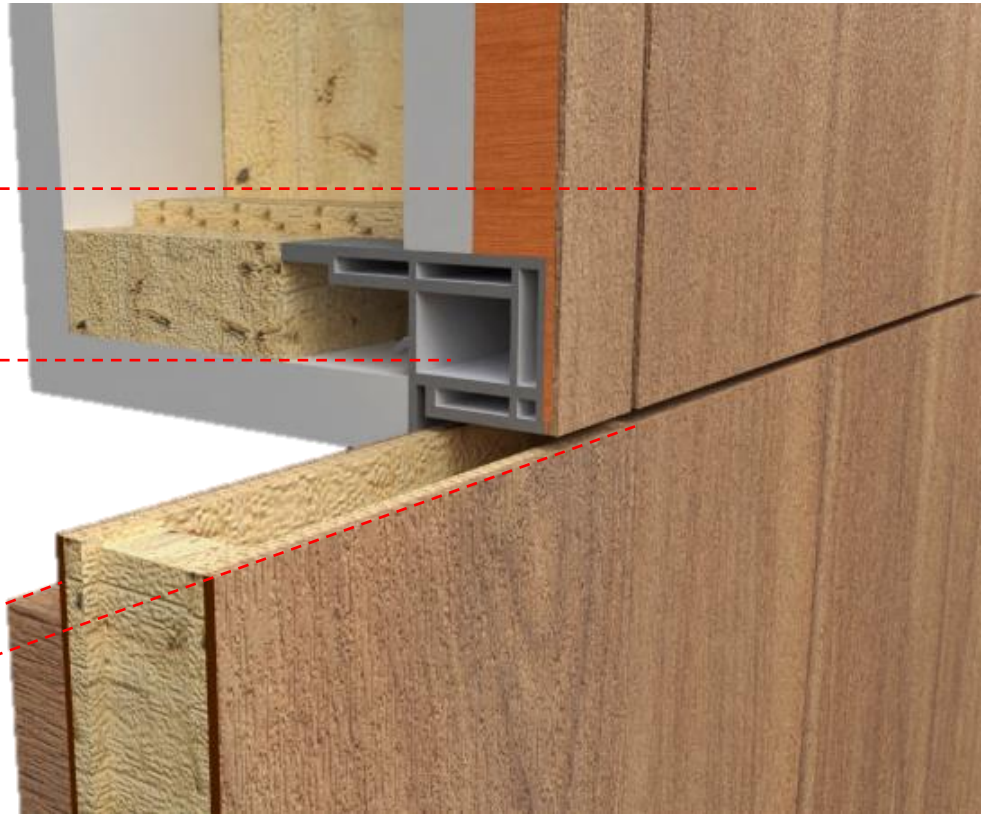

In-swing Profile

Panel Wall

Inswing Profile

Inswing True Door Height

Visible Door Height =
True Door Height - 1/2"

Panel Door

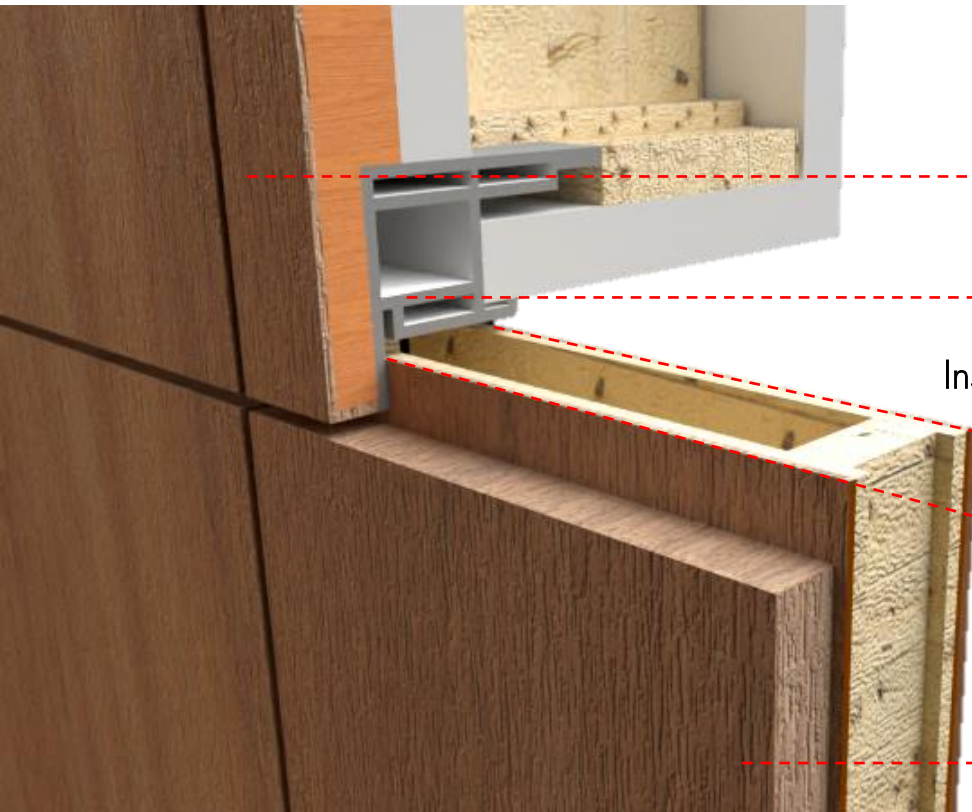

Panel Layout Options

Full Height

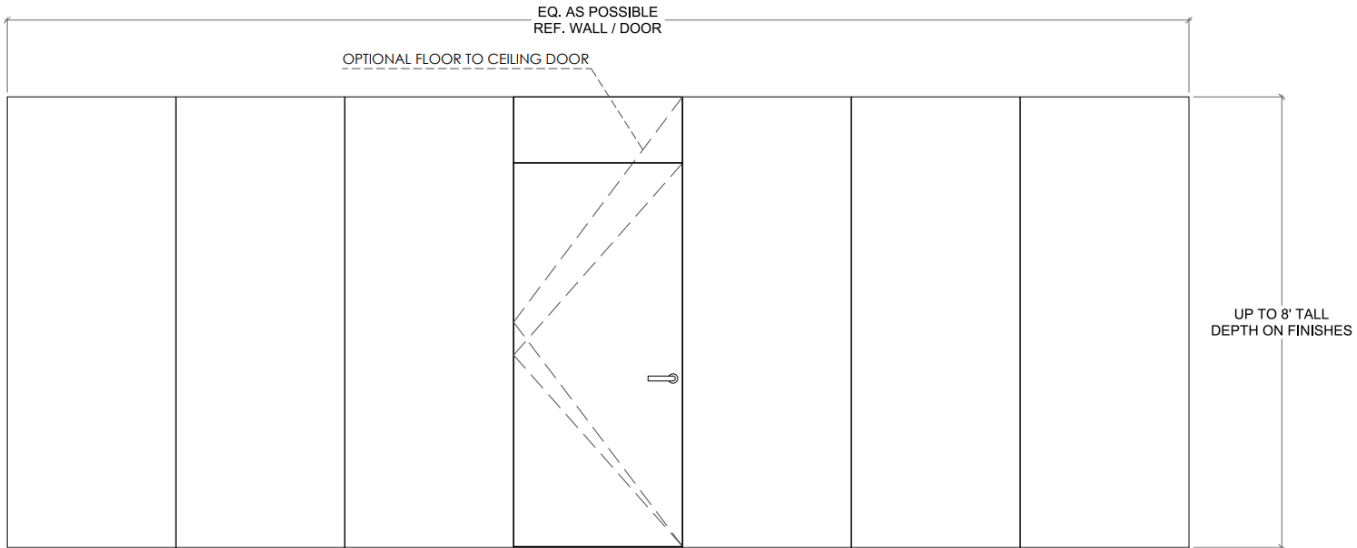

Mirrored Height

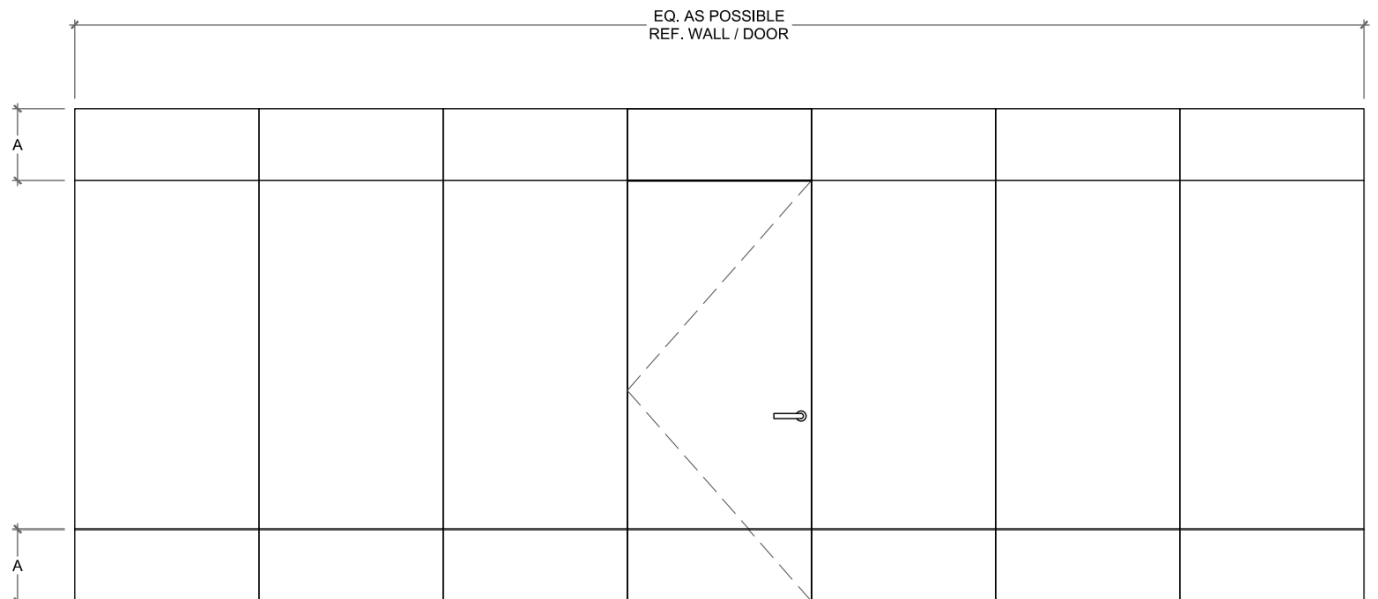

PLEASE ACCOUNT FOR FINISHED FLOOR FOR ALL MEASUREMENTS GIVEN TO DAYORIS.

Panel Layout Options

Reversed Height

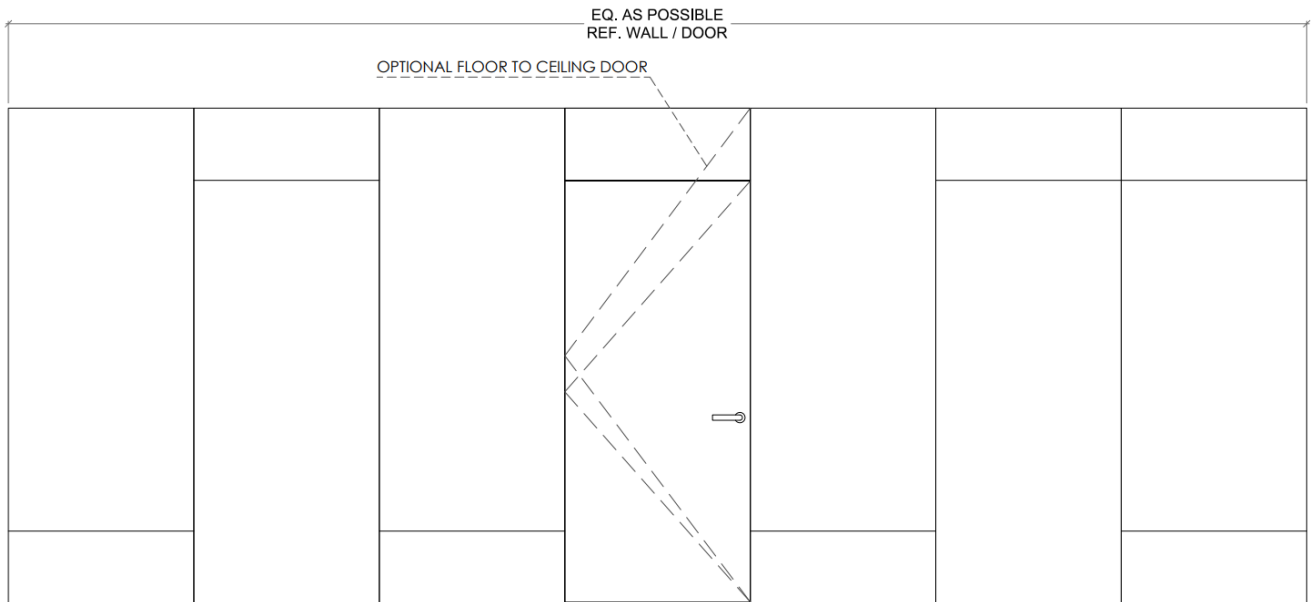

Blocks I

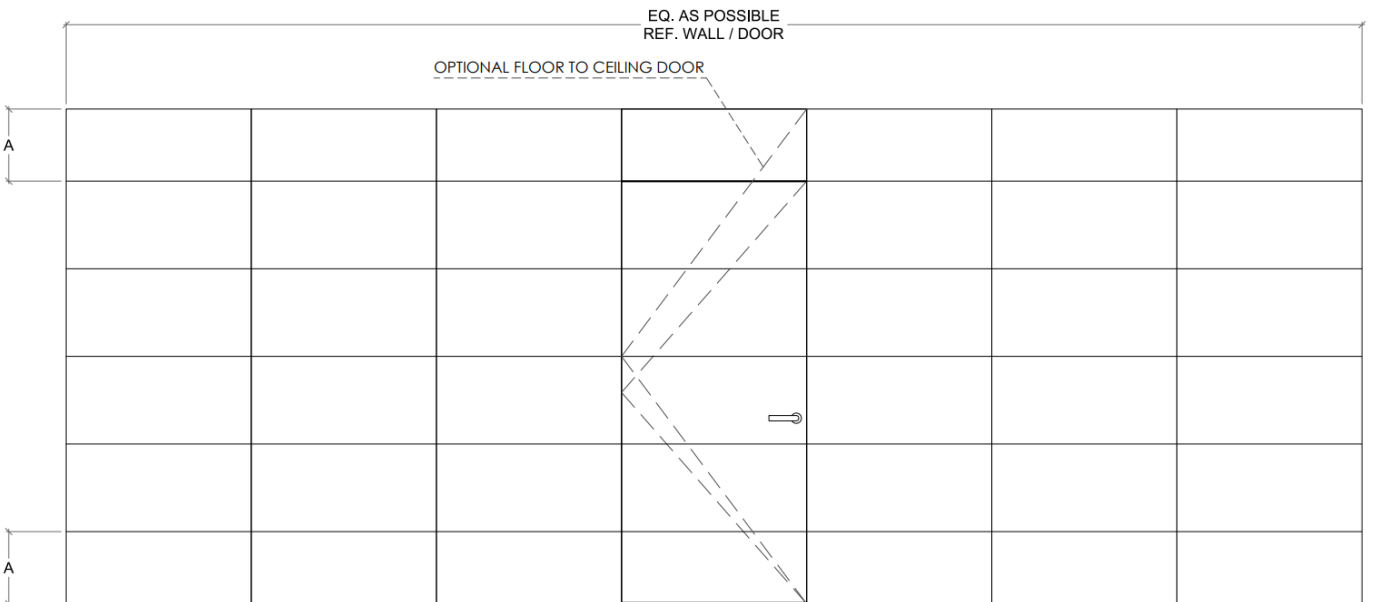

PLEASE ACCOUNT FOR FINISHED FLOOR FOR ALL MEASUREMENTS GIVEN TO DAYORIS.

Panel Layout Options

Door Height

EQ. AS POSSIBLE
REF. WALL / DOOR

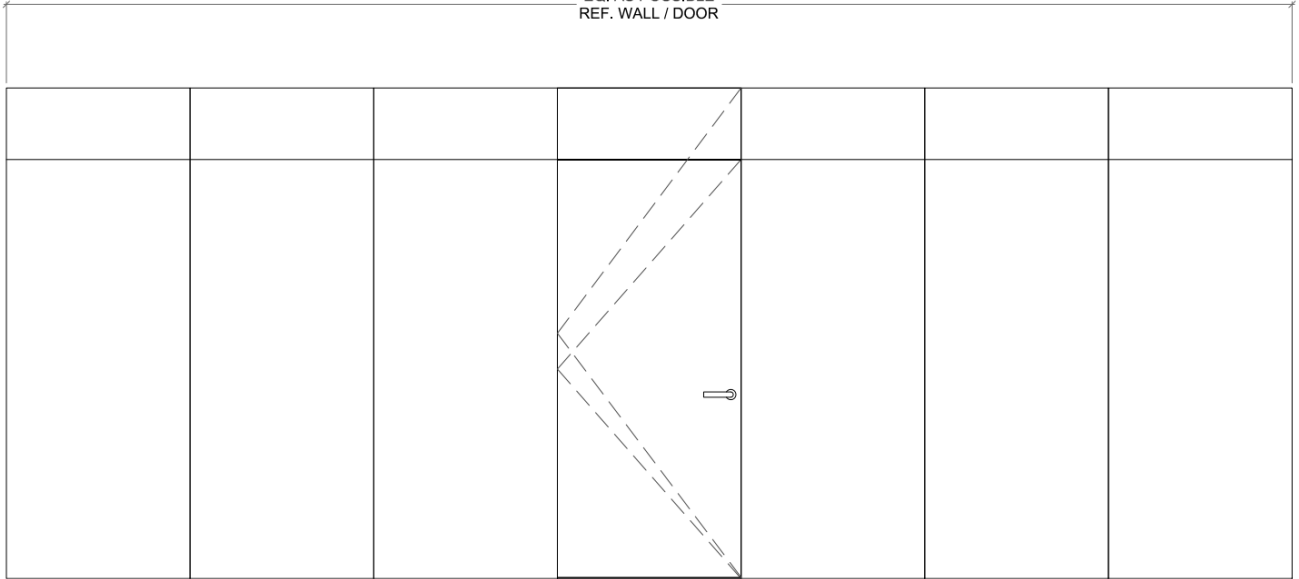

Split Height

EQ. AS POSSIBLE
REF. WALL / DOOR

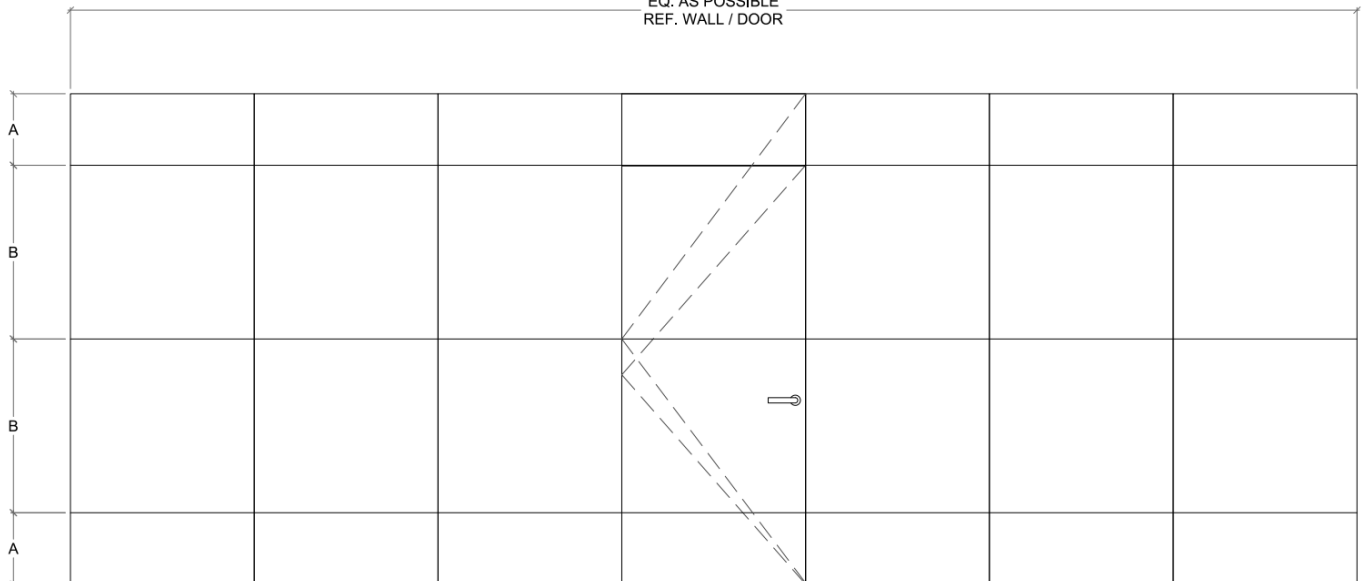

PLEASE ACCOUNT FOR FINISHED FLOOR FOR ALL MEASUREMENTS GIVEN TO DAYORIS.

Panel Layout Options

Hardware Highlight

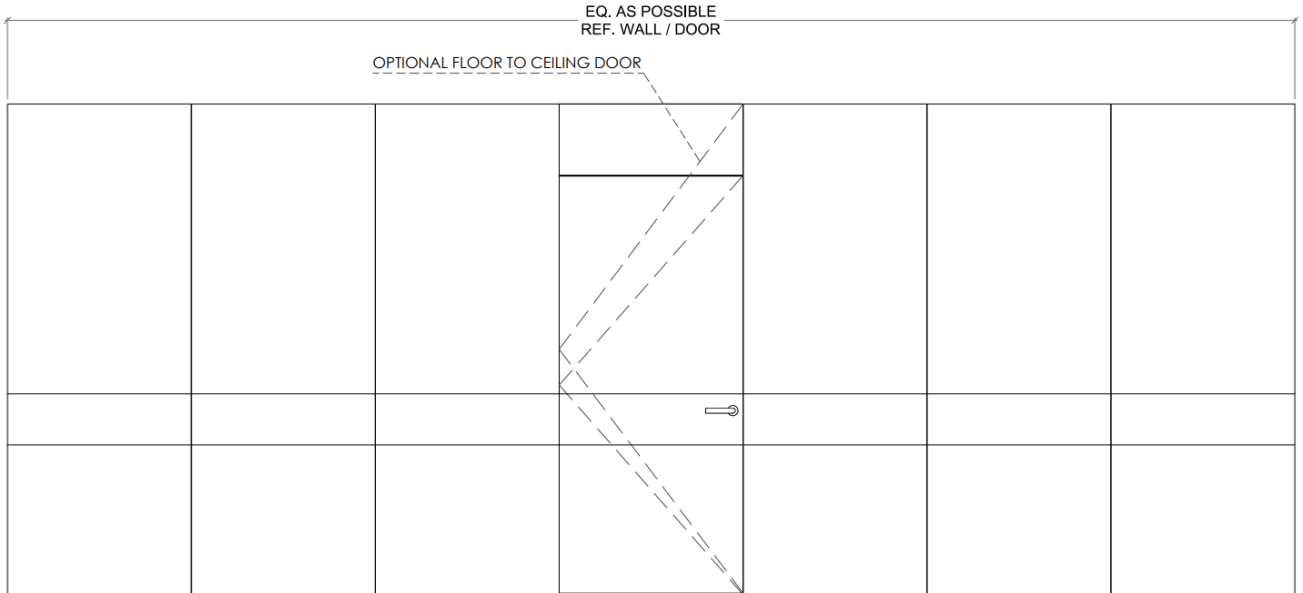

Blocks II

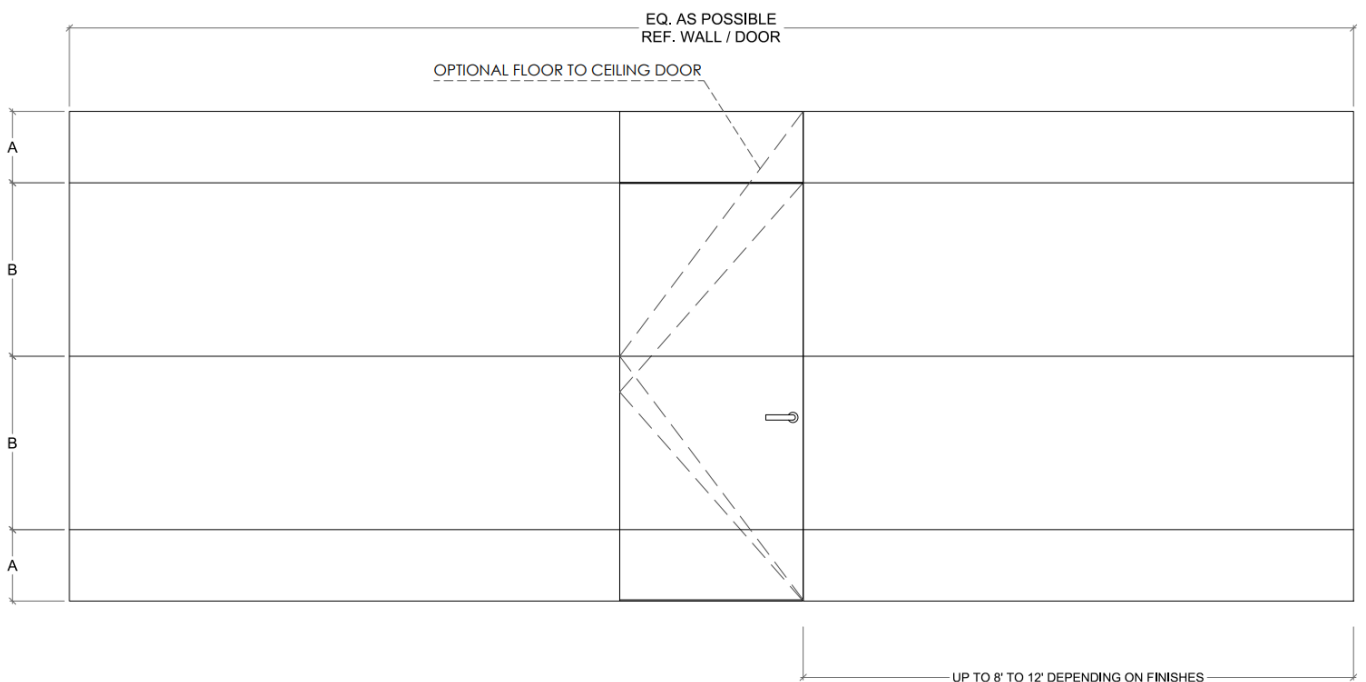

PLEASE ACCOUNT FOR FINISHED FLOOR FOR ALL MEASUREMENTS GIVEN TO DAYORIS.