

Filo muro/ frameless, flush to the wall

EURO DOOR



Types of Applications



Finishes

Primed / Laminated Import

Laminated Suncrest / Matte Lacquer

Wood veneer

Cabinet Knob



L Profile



Cabinet Style Hinge



What's included

Technical Specifications:

1" Solid Core MDF Door

Finish – Designer's choice

Frame – Concealed aluminum

Design – Designers Choice

Frame Profile Finishes

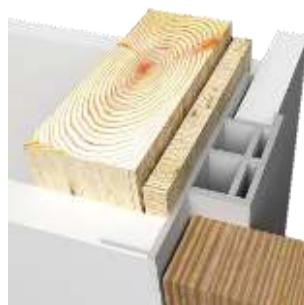

Clear Aluminum Frame

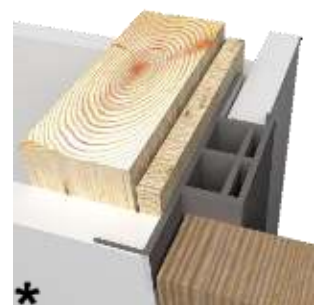

* Black Aluminum Frame

* Optional Upgrades

Benefits of Filo muro/ euro door

Drywall Return

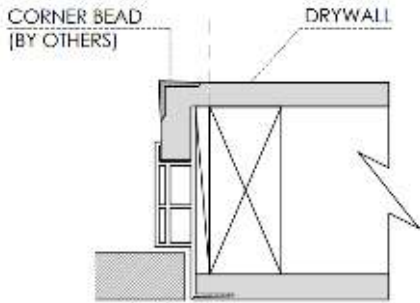

Any Wall Thickness

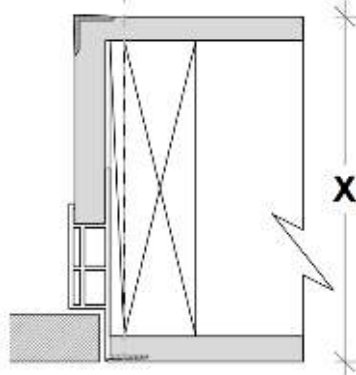

Lighter Door and Space saver

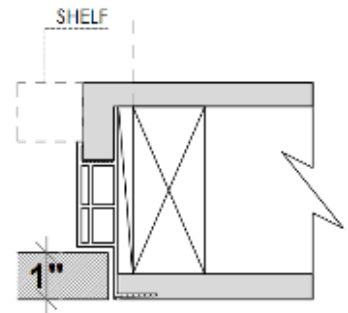

A thinner, economical application for non walk-in closets

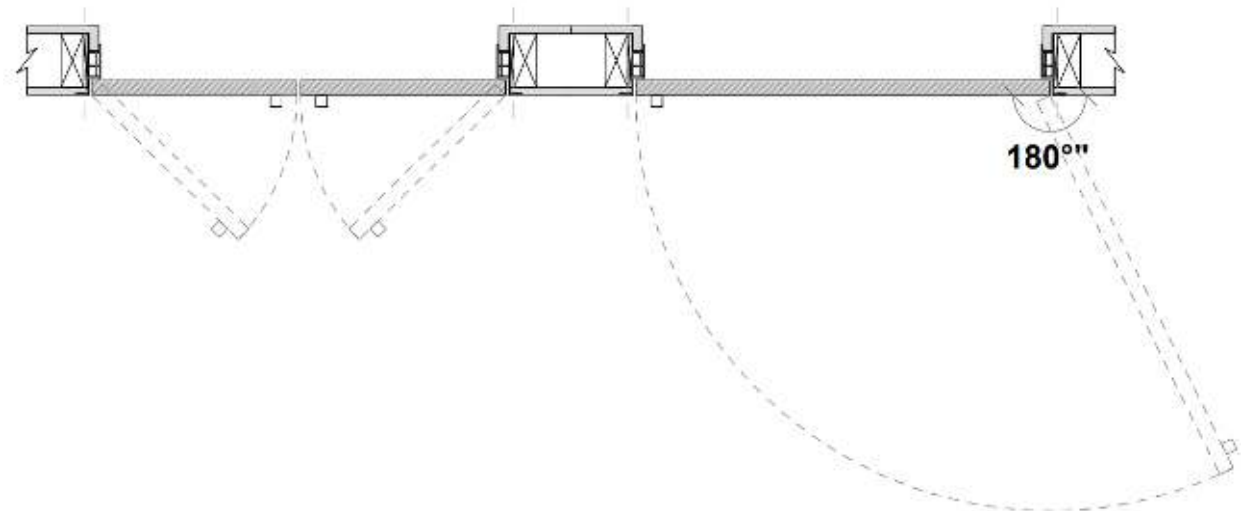

Works with 1/2" depth reglet (any height). Can be used with 5/8" drywall.

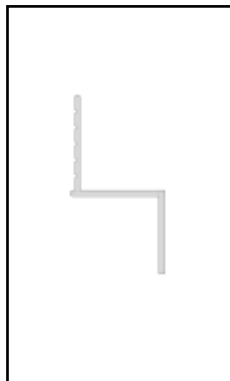

DEPTH	WIDTH	NON-VENTED
1/2"	1/8"	DRMZ-25-125
1/2"	1/4"	DRMZ-50-25
1/2"	3/8"	DRMZ-50-375
1/2"	1/2"	DRMZ-50-50
1/2"	5/8"	DRMZ-50-625
1/2"	3/4"	DRMZ-50-75
1/2"	1"	DRMZ-50-100
1/2"	1 1/2"	DRMZ-50-150
1/2"	2"	DRMZ-50-200

* Fry reglet for reference purposes only, not provided by Dayoris.

Framing Instructions Filo muro/ euro door

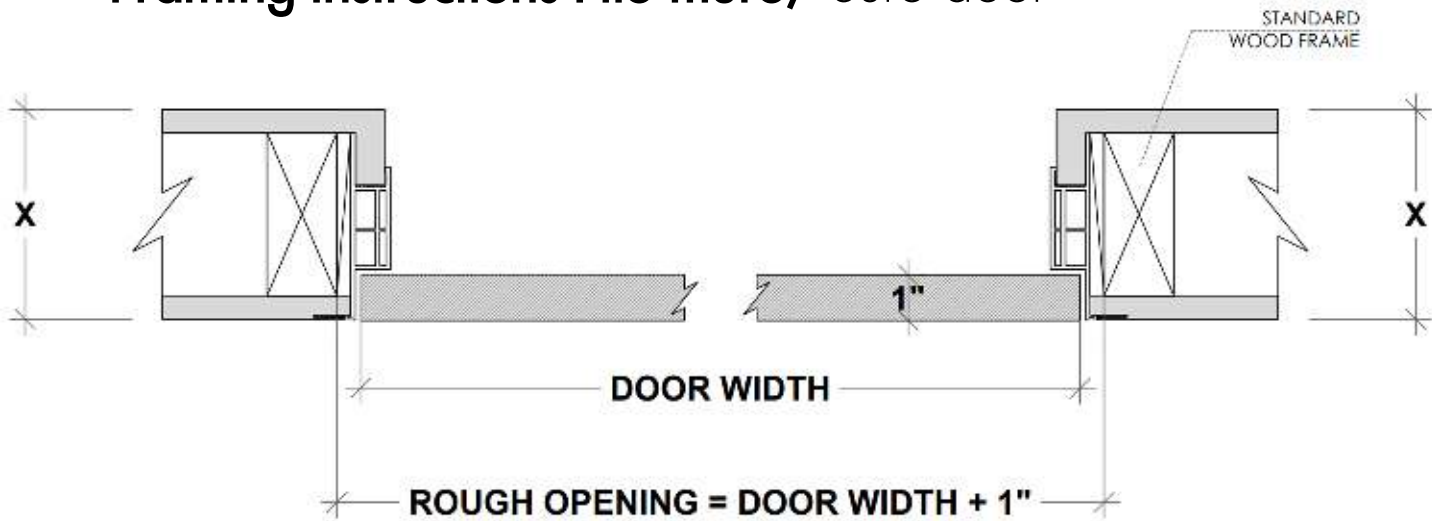

X = THE WALL CAN BE ANY THICKNESS
ALL OPENINGS MUST HAVE WOOD SUPPORT (2" x 4", 2" x 6", 2" x 8", ...)

Standard Application

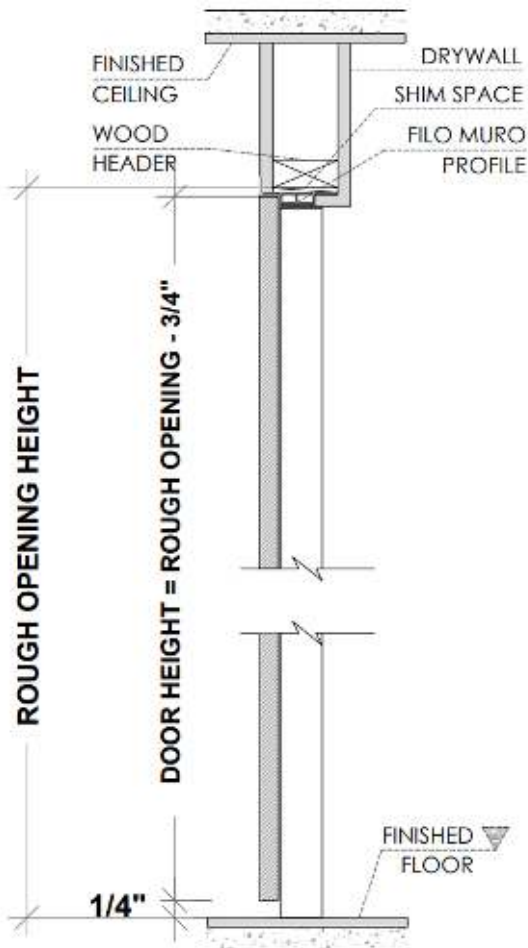

Floor to Ceiling Application

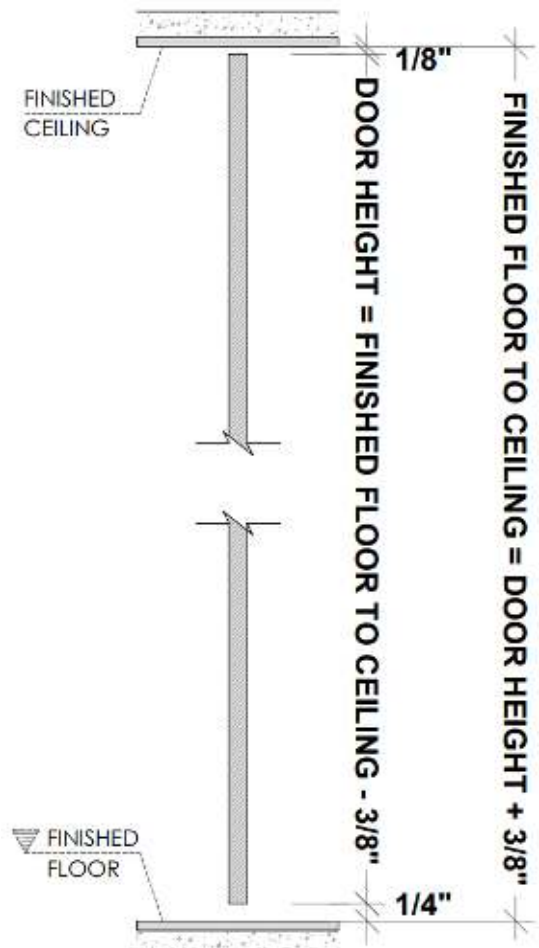

PLEASE ACCOUNT FOR FINISHED FLOOR FOR ALL MEASUREMENTS GIVEN TO DAYORIS.

Outswing Application (euro door only available outswing)

Right Hand Outswing

Left Hand Outswing

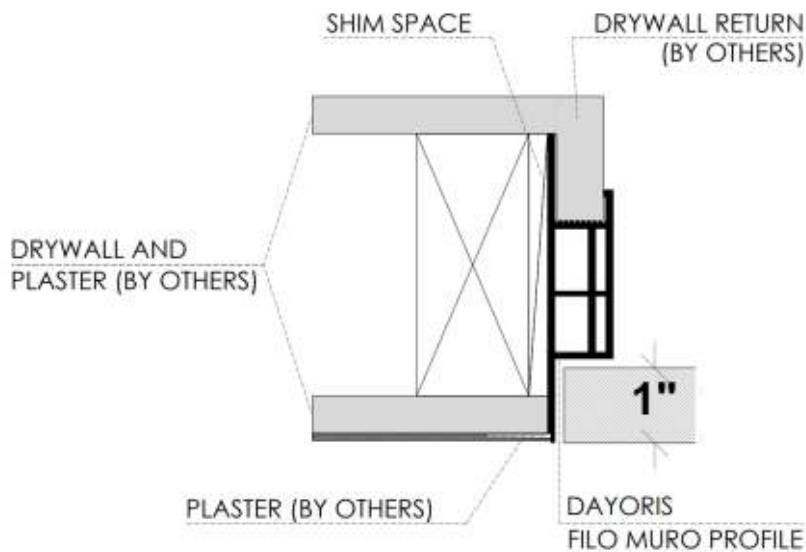
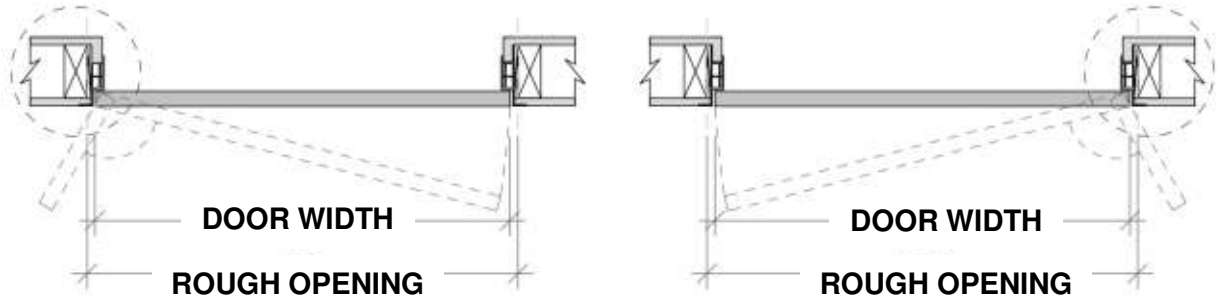

Double Door Applications

Double Dummy Application (both active)

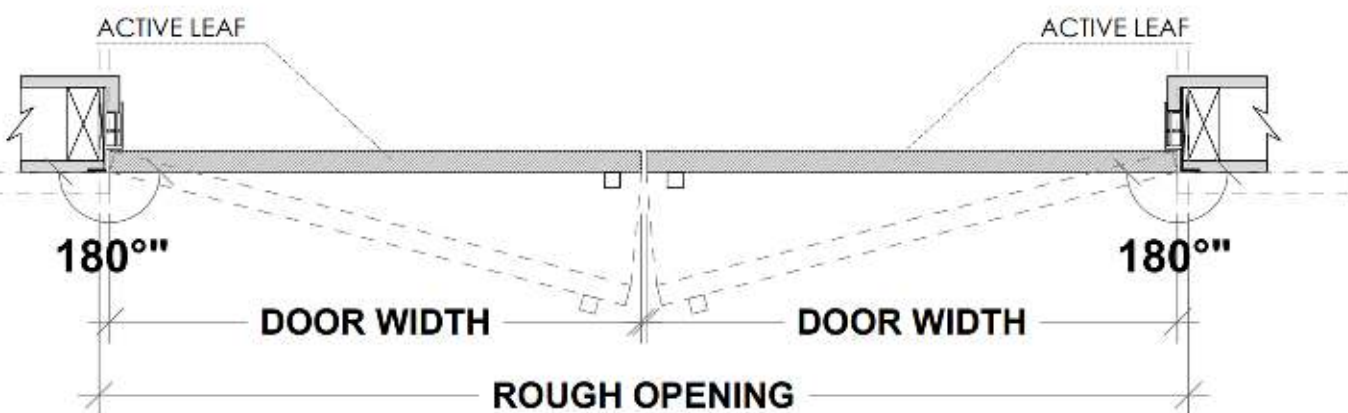

$$\text{ROUGH OPENING} = (\text{DOOR WIDTH} \times 2) + 1''$$