

Filo/ with casing

POCKET DOOR



Types of Applications



Finishes

- Primed / Laminated Import
- Laminated Suncrest / Matte Lacquer
- Wood veneer

What's included

- Technical Specifications:
- Solid Core Door Slab
- Finish – Designer's choice
- Handset – DAYORIS Italia
- Design – Designers Choice

Applications

Standard Application



Floor to Ceiling Application *



* Optional Upgrade

1. Builders grade Pocket Frame Kit

Limited to Door size up to 3' x 8'

Usually provided by others, available from Dayoris as an optional upgrade. (for optimal use, Dayoris recommend option 2, framing with 2x6).

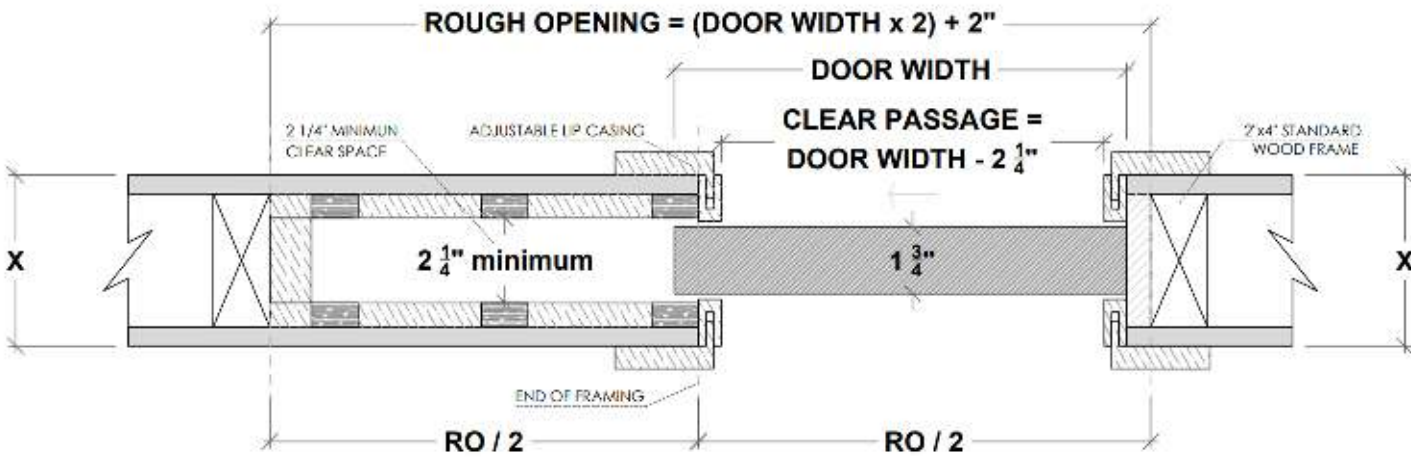

X = THE WALL CAN BE ANY THICKNESS
ALL OPENINGS MUST HAVE WOOD SUPPORT (2 x 4, 2 x 6, 2 x 8, ...)

1.a Standard Application with Builders Pocket Frame

HAFELE Track
 $\text{RO} = \text{DH} (\text{Door Height}) + 2\frac{3}{4}''$
 (from Finished Floor)

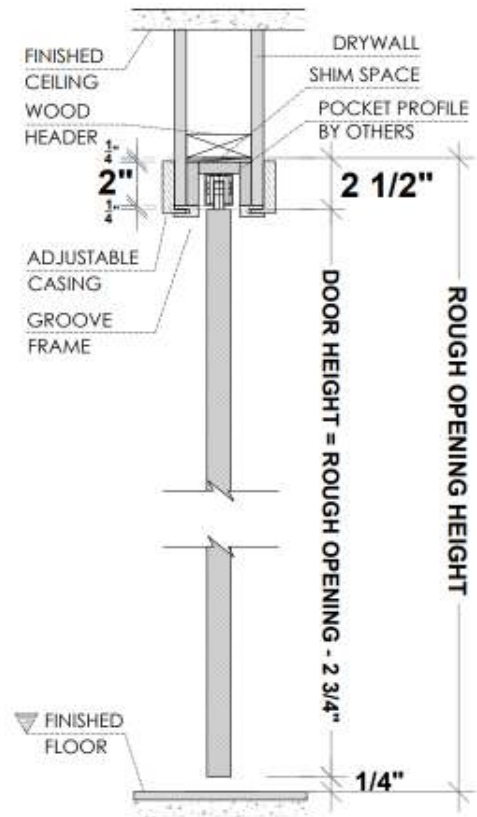

PLEASE ACCOUNT FOR FINISHED FLOOR FOR ALL MEASUREMENTS GIVEN TO DAYORIS

1.b Floor to Ceiling Application with Builders Pocket Frame Kit

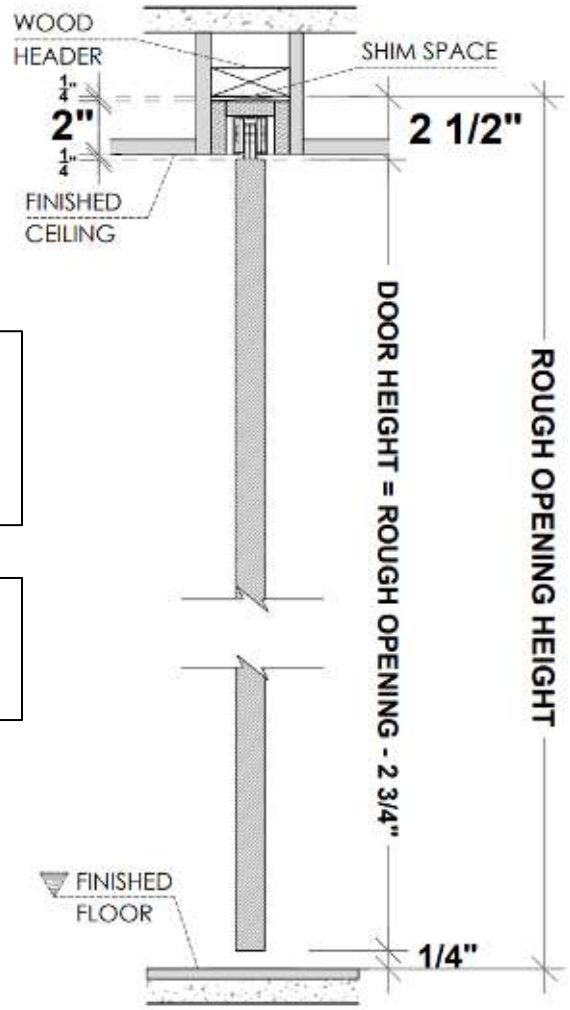

HAFELE Track
 $RO = DH \text{ (Door Height)} + 2 \frac{3}{4}''$
 (from Finished Floor)

DH (Door Height) =
 Finished Floor to Finished Ceiling - $\frac{1}{2}''$

Support at 2 1/4" above finished ceiling

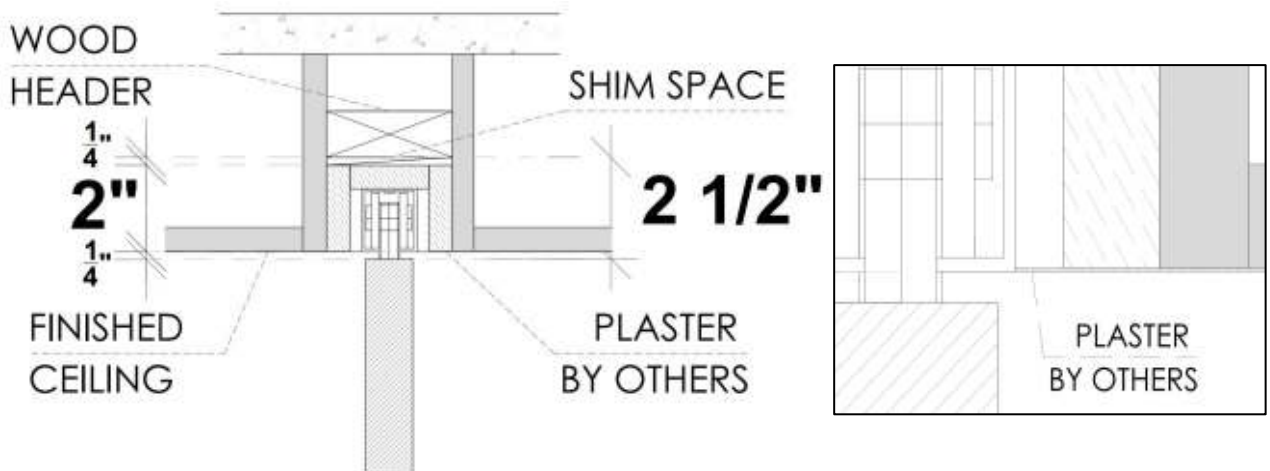

PLEASE ACCOUNT FOR FINISHED FLOOR FOR ALL MEASUREMENTS GIVEN TO DAYORIS

2. Pocket Frame with 2x6 and 1 5/8" Studs Structure (by others)

Recommended Application

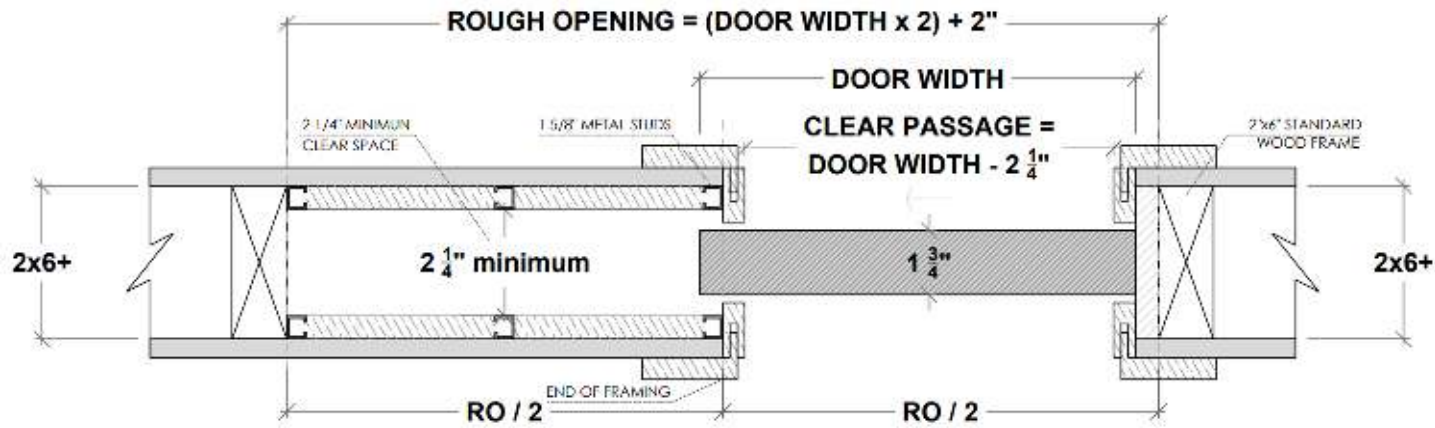

ALL OPENINGS MUST HAVE WOOD SUPPORT (2x6)

2.a Standard Application with 2x6 Frame and 1 5/8" Studs

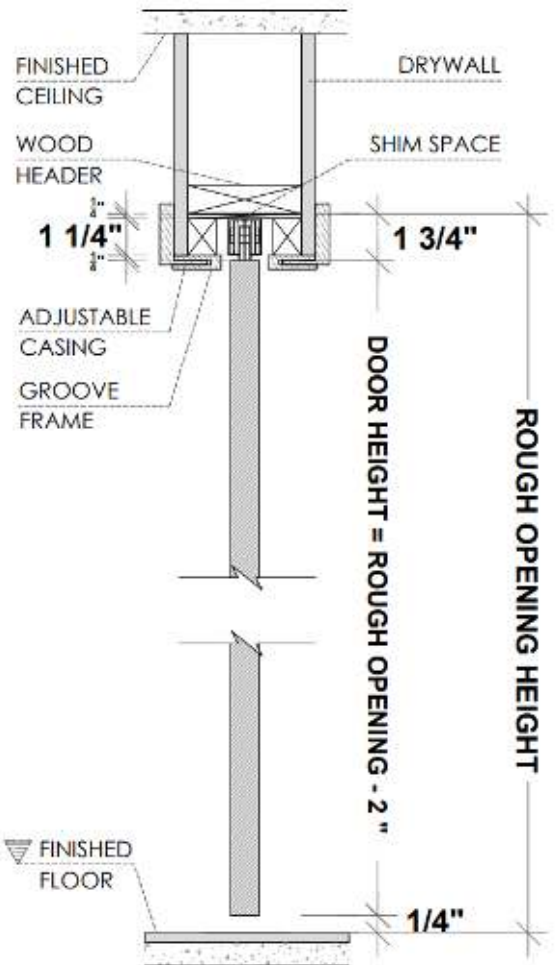

HAFELE Track
 $RO = DH \text{ (Door Height)} + 2"$
 (from Finished Floor)

PLEASE ACCOUNT FOR FINISHED FLOOR FOR ALL MEASUREMENTS GIVEN TO DAYORIS

2.b Floor to Ceiling Application with 2x6 and 1 5/8" Studs

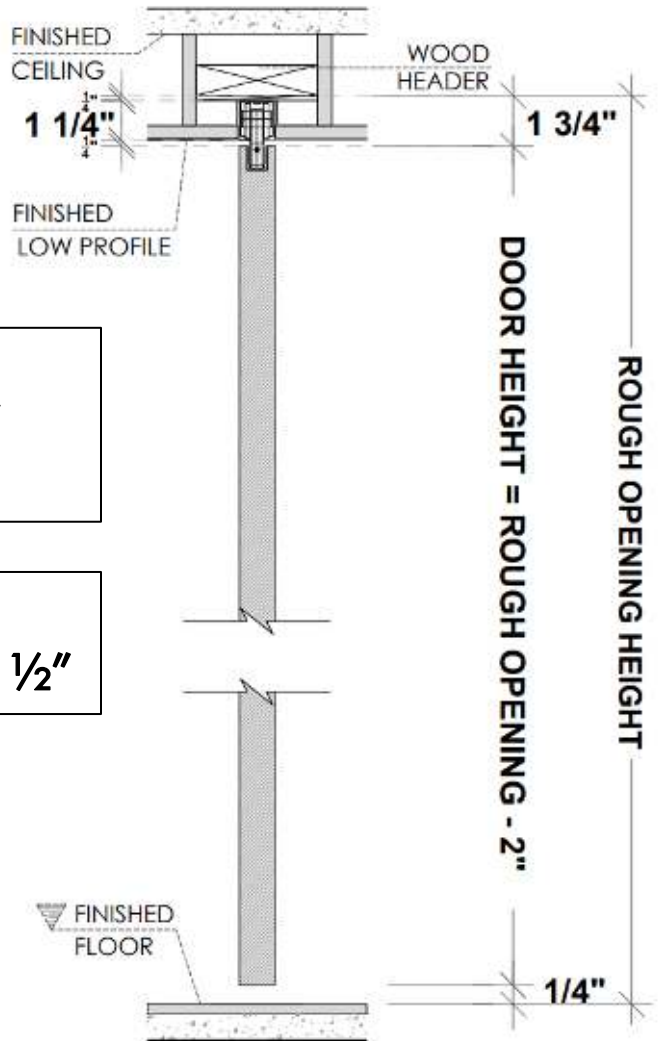

HAFELE Track
 $RO = DH \text{ (Door Height)} + 2''$
 (from Finished Floor)

$DH \text{ (Door Height)} =$
 Finished Floor to Finished Ceiling - 1/2"

Support at 1 1/2" above finished ceiling

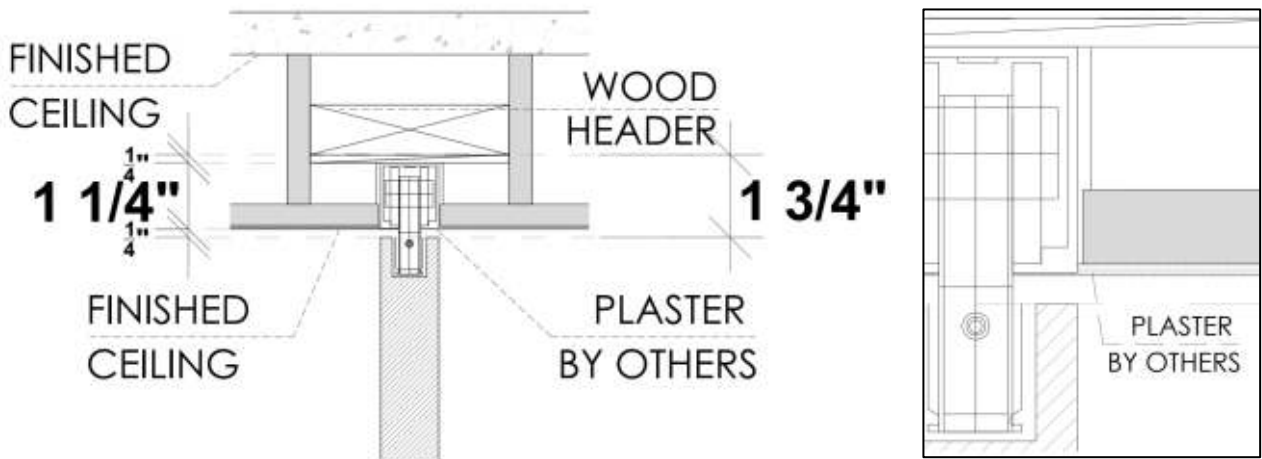

3. Pocket Frame with 2x6 and 1 5/8" Studs Structure with Shadow Reveal (by others)

Recommended Application

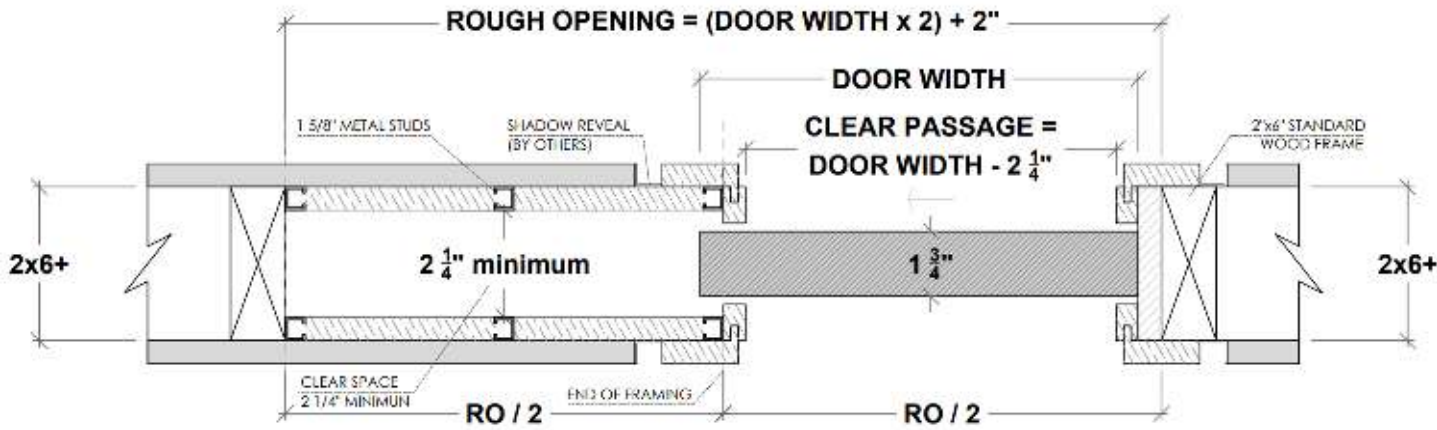

ALL OPENINGS MUST HAVE WOOD SUPPORT (2x6)

2.a Standard Application with 2x6 Frame and 1 5/8" Studs

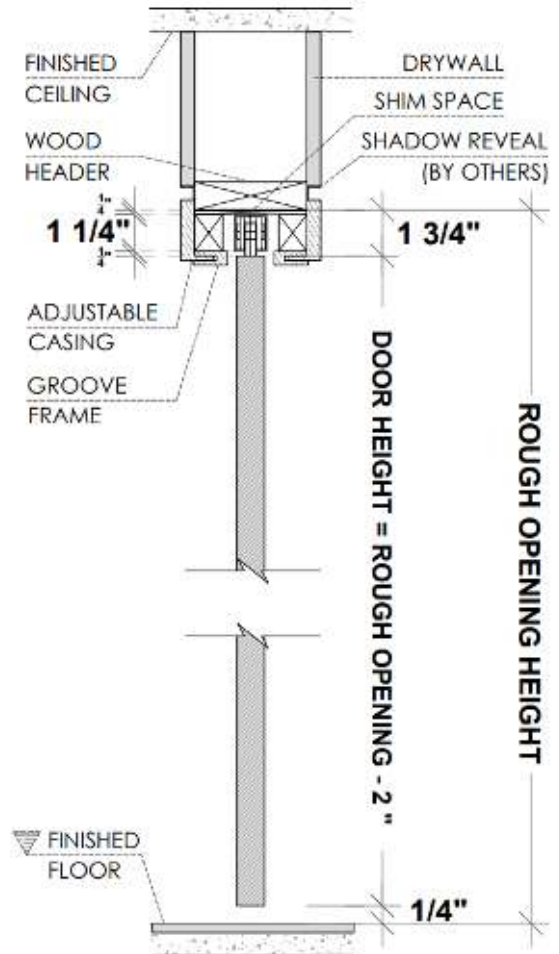

HAFELE Track
 $RO = DH \text{ (Door Height)} + 2''$
 (from Finished Floor)

PLEASE ACCOUNT FOR FINISHED FLOOR FOR ALL MEASUREMENTS GIVEN TO DAYORIS

Hardware

Pocket and Sliding Door Hardware

Satin



Polished



Black

