

Filo/ with casing

PIVOT DOOR



DAYORIS
DOORS

Types of Applications



Finishes

- Primed / Laminated Import
- Laminated Suncrest / Matte Lacquer
- Wood veneer

Ives Pivot Hinge

Ceiling / Header

Bottom of the Door

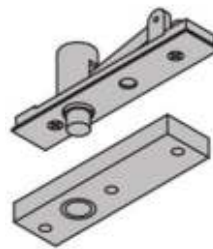

Door

Floor

What's included

- Technical Specifications:
- Solid Core Door Slab
- Finish – Designer's choice
- Hinges – IVES Pivot
- Frame – Concealed aluminum
- Handset – DAYORIS Italia
- Mortise – Bonaiti Magnetic
- Design – Designers Choice

Frame Profile Finishes



Clear Aluminum Frame



Black Aluminum Frame *

* Optional Upgrades

Benefits of Filo/ pivot door

Adjustable Casing

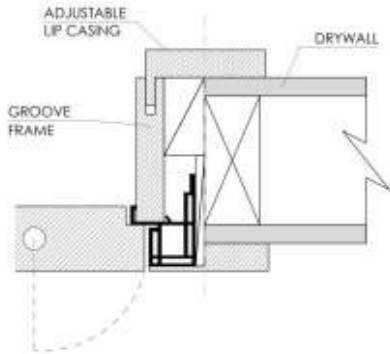

Any Wall Thickness

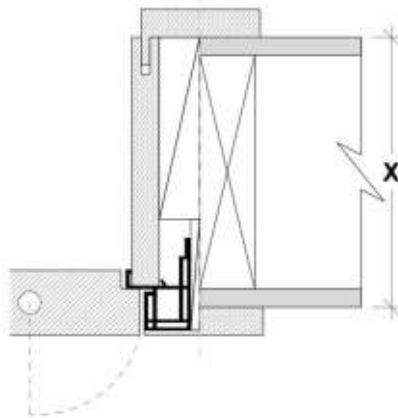

Casing can be flush to the wall

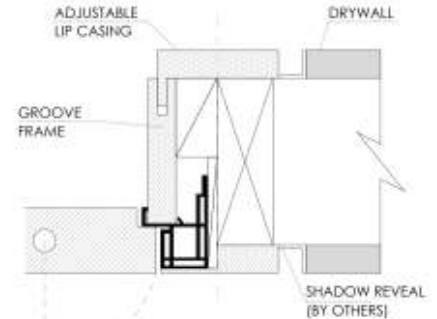

Always flush on the outside of the wall regardless of the door swing.

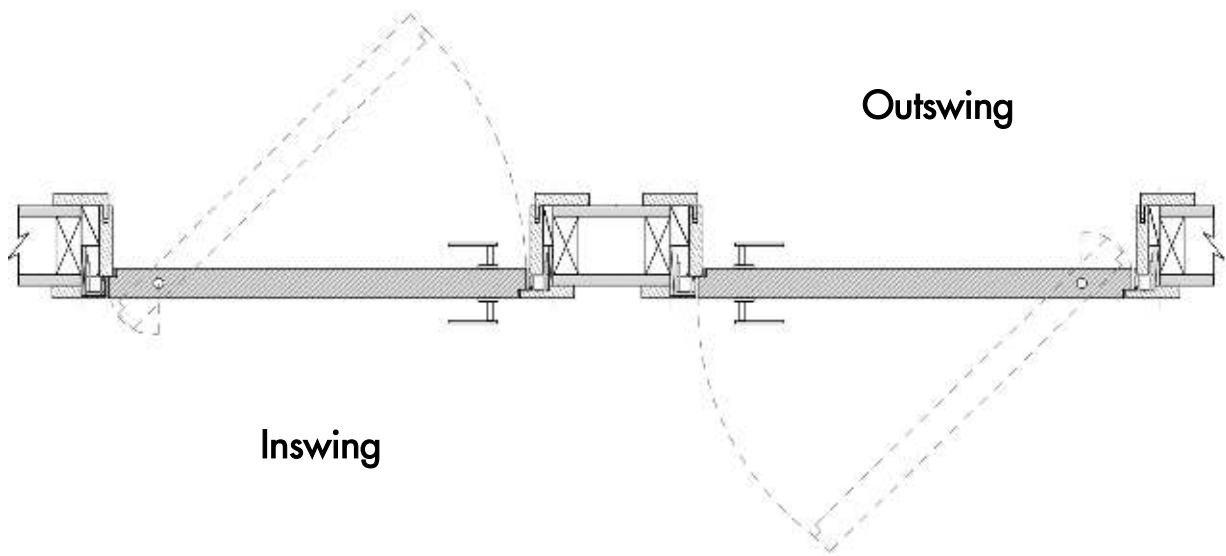

Works with 1/2" depth reglet (any height). Can be used with 5/8" drywall.

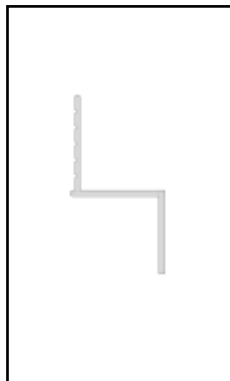

DEPTH	WIDTH	NON-VENTED
1/2"	1/8"	DRMZ-25-125
1/2"	1/4"	DRMZ-50-25
1/2"	3/8"	DRMZ-50-375
1/2"	1/2"	DRMZ-50-50
1/2"	5/8"	DRMZ-50-625
1/2"	3/4"	DRMZ-50-75
1/2"	1"	DRMZ-50-100
1/2"	1 1/2"	DRMZ-50-150
1/2"	2"	DRMZ-50-200

* Fry reglet for reference purposes only, not provided by Dayoris.

Framing Instructions Filo/ pivot door

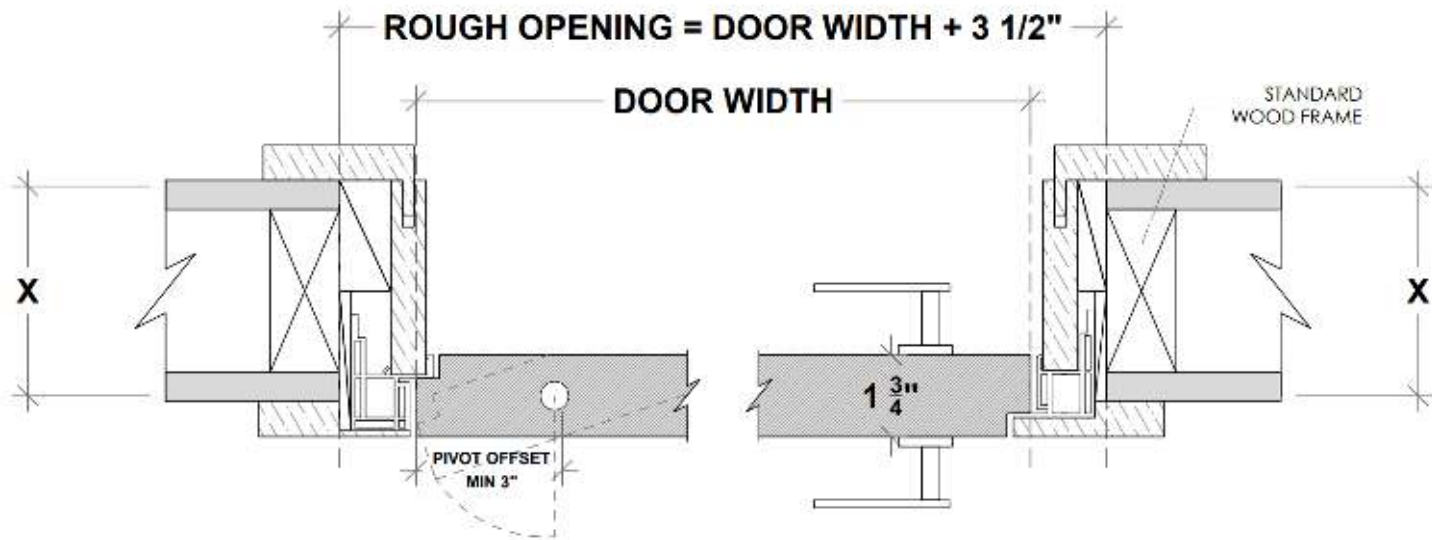

X = THE WALL CAN BE ANY THICKNESS
ALL OPENINGS MUST HAVE WOOD SUPPORT (2" x 4", 2" x 6", 2" x 8", ...)

Standard Application

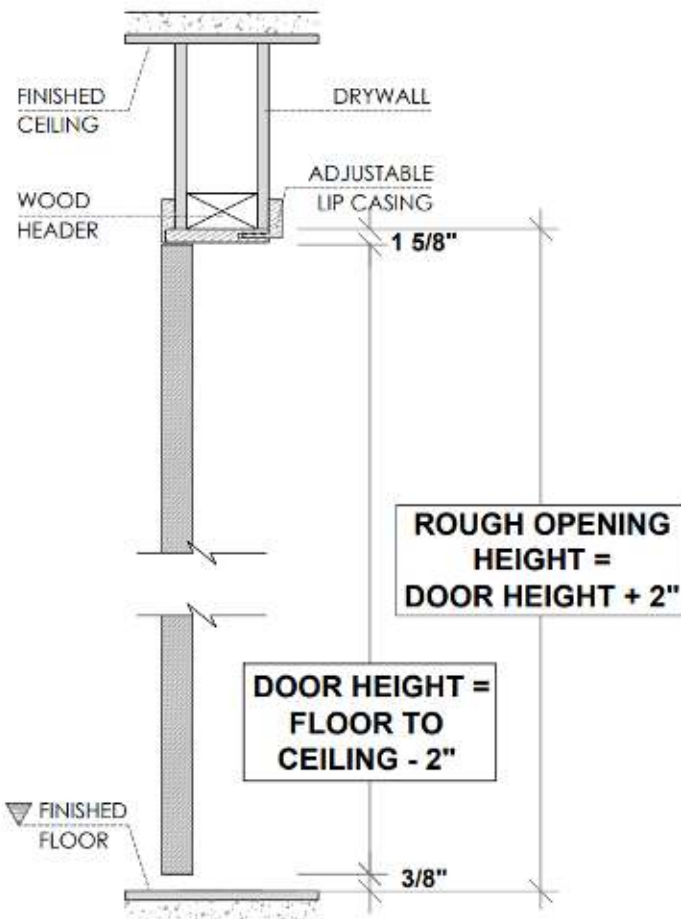

Floor to Ceiling Application

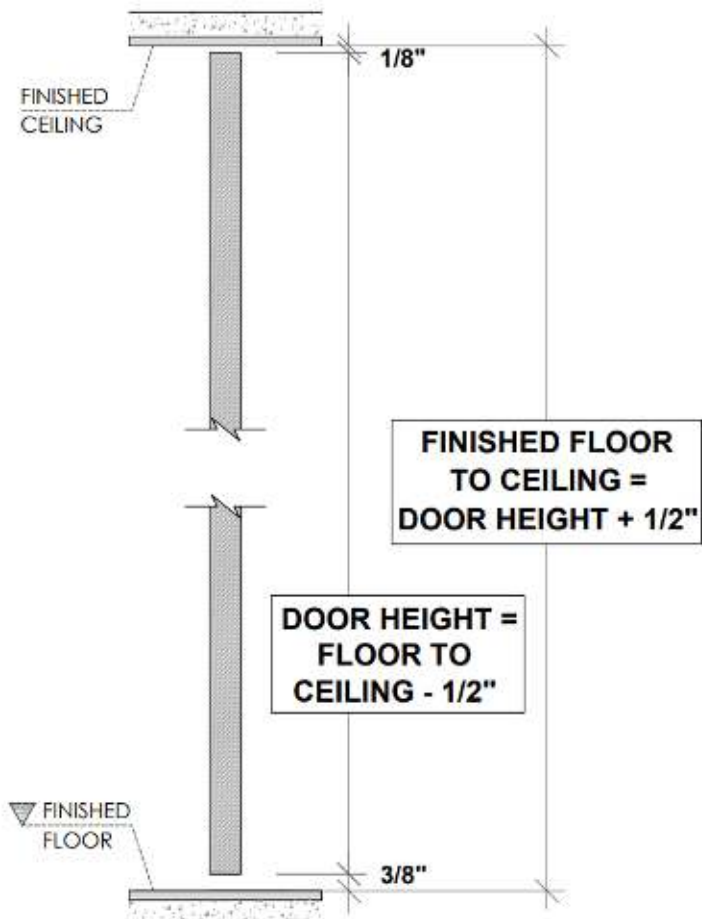

PLEASE ACCOUNT FOR FINISHED FLOOR FOR ALL MEASUREMENTS GIVEN TO DAYORIS.

Inswing Application

Left Hand Inswing

Right Hand Inswing

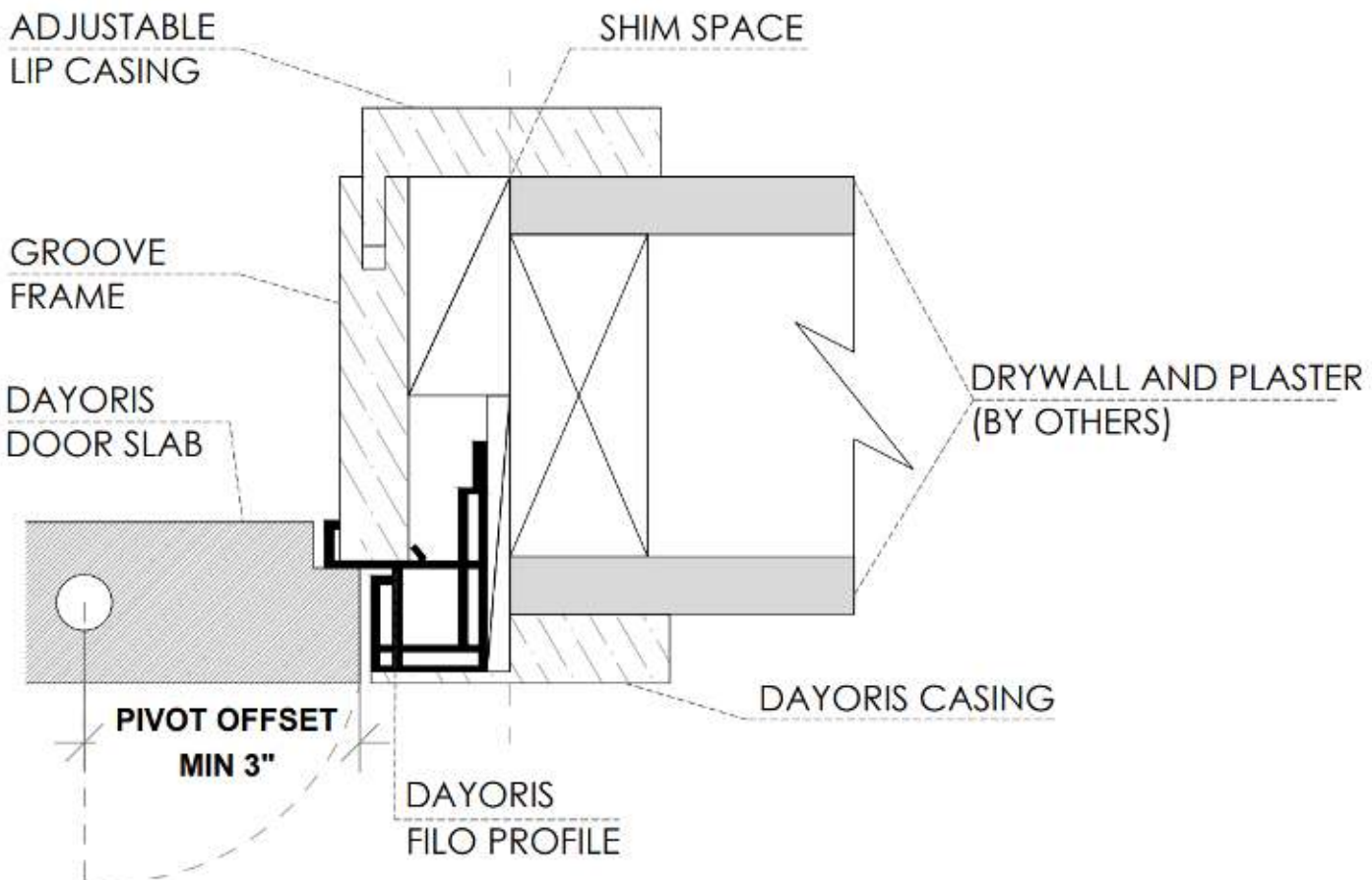
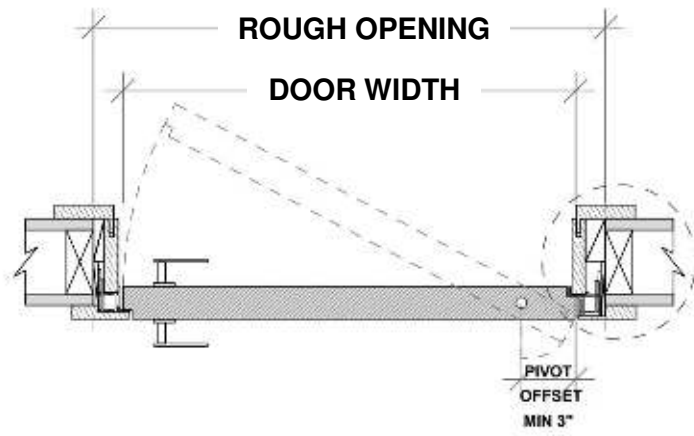
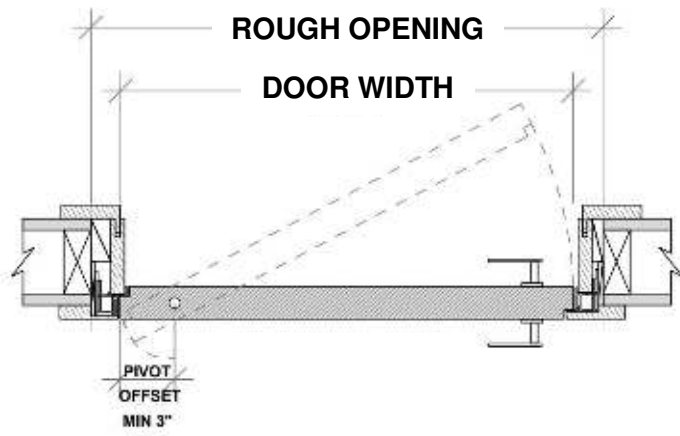

Outswing Application

Right Hand Outswing

Left Hand Outswing

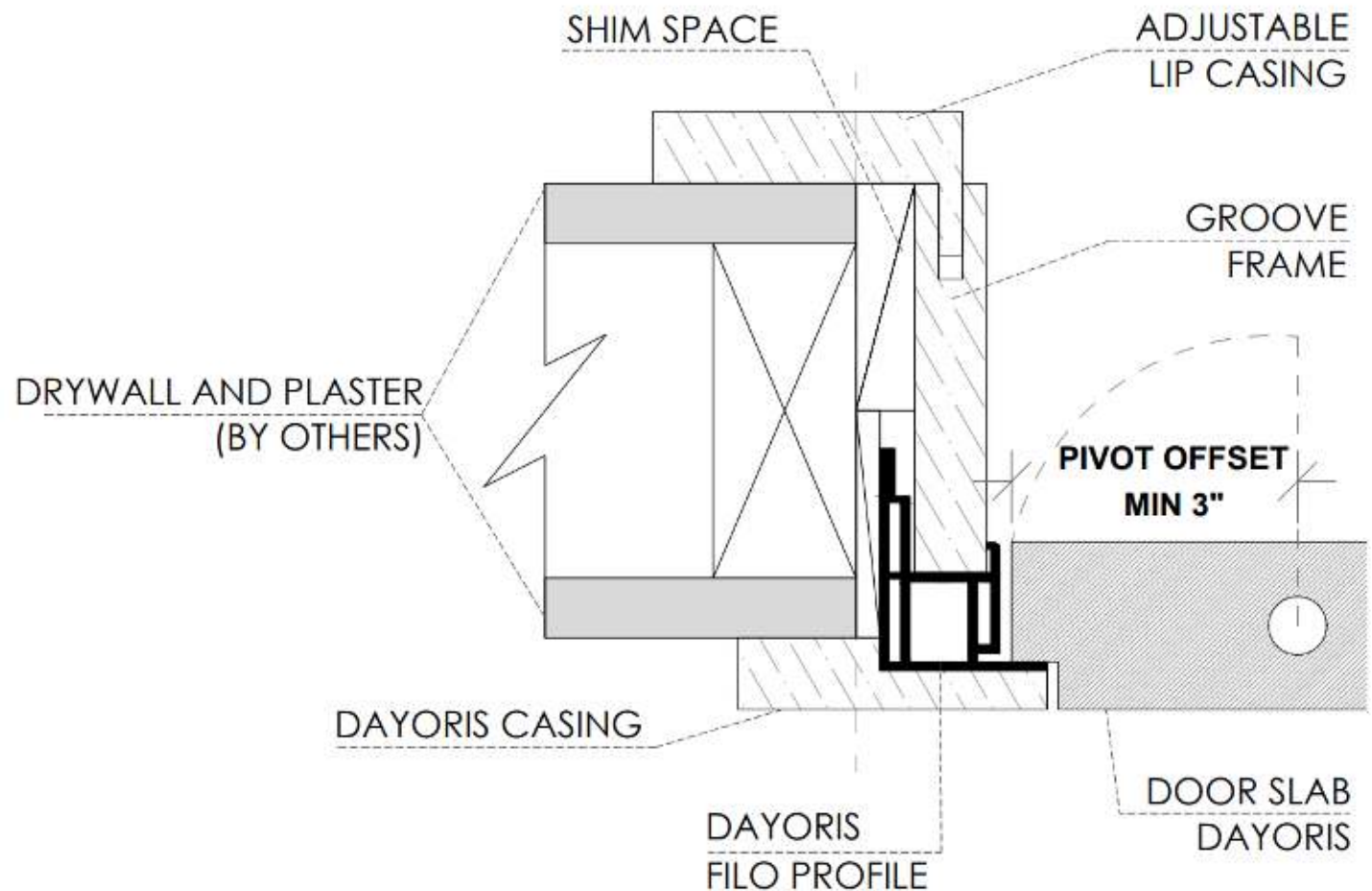
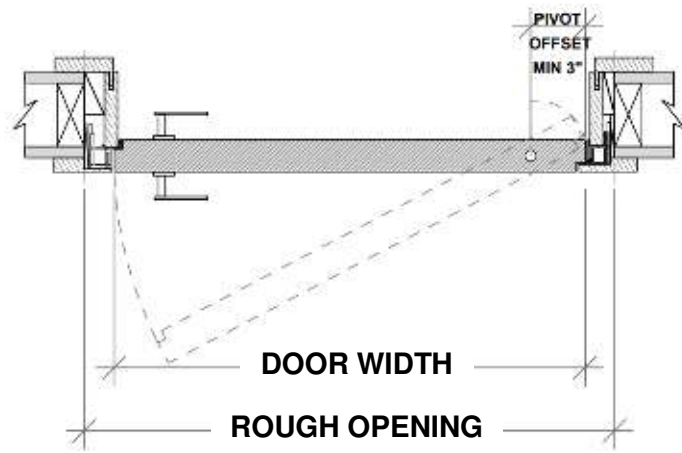
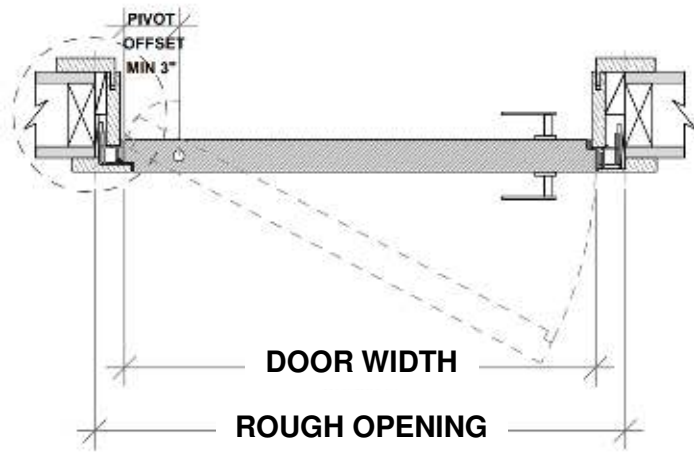

Double Door Applications

Double Dummy Application with top magnetic catch (both active)

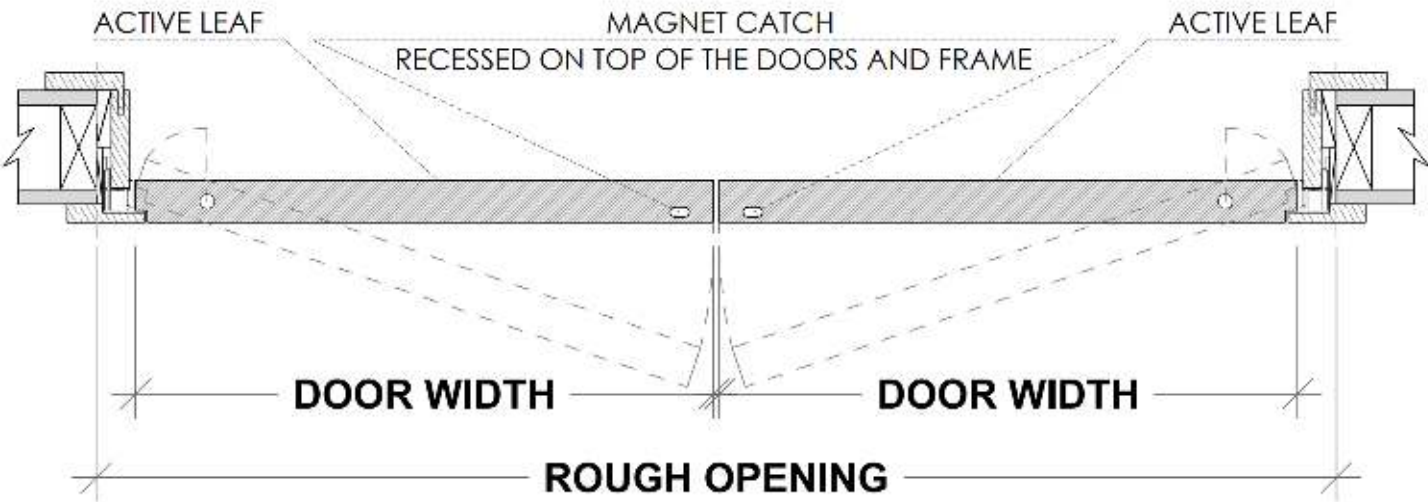

Active / Inactive Door with flush bolts

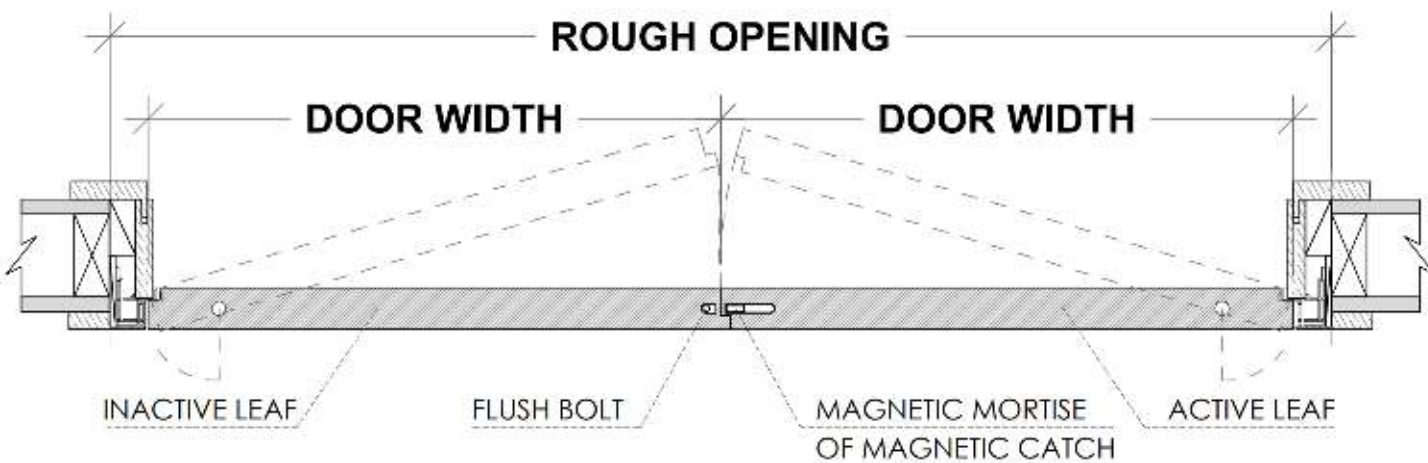

RHA (RIGHT HAND ACTIVE) SHOWN

$$\text{ROUGH OPENING} = (\text{DOOR WIDTH} \times 2) + 3 \frac{1}{2}"$$

Filo with Transom Application

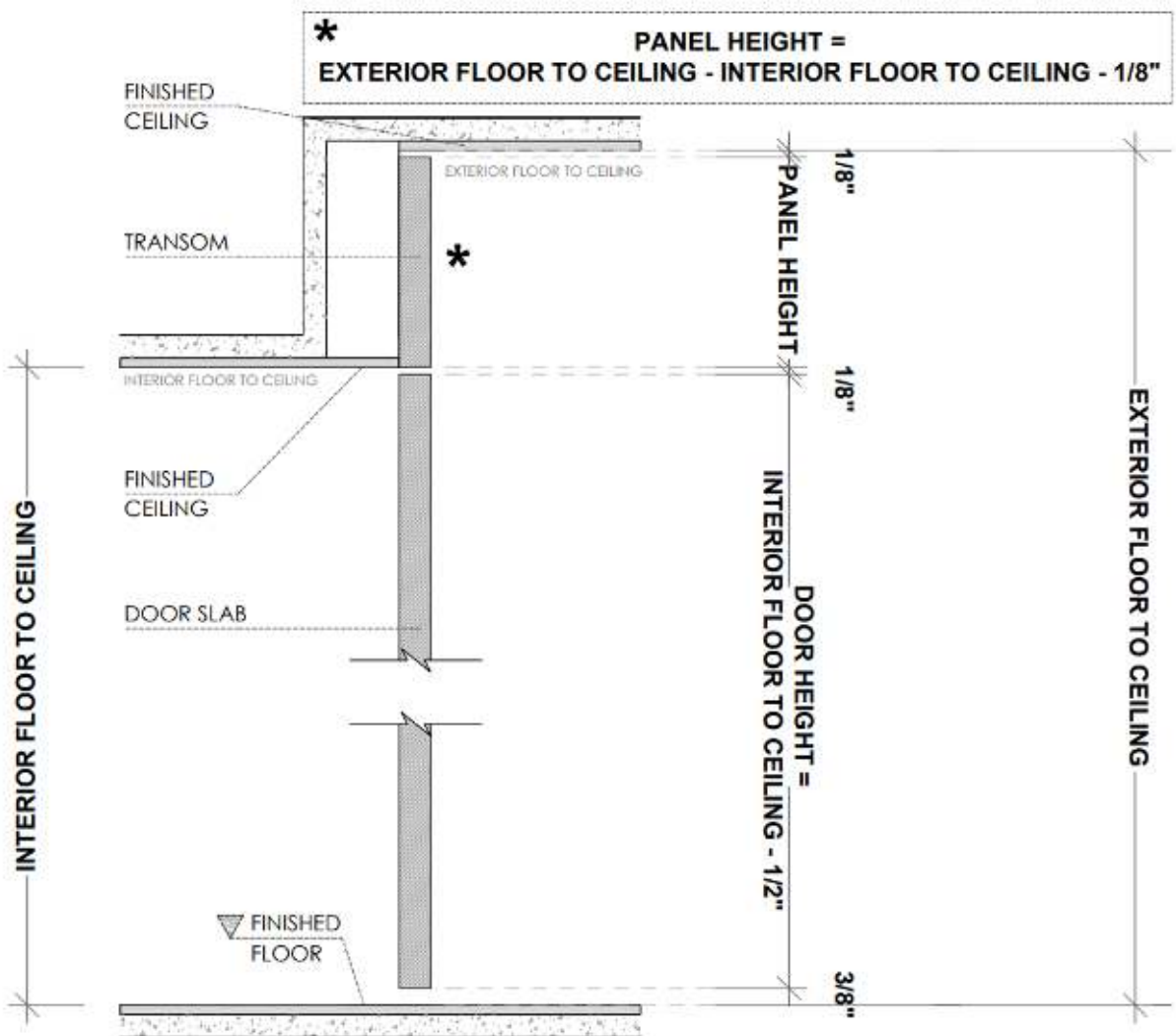

Hardware



ROUND SATIN



SQUARE SATIN



FLAT ROUND SATIN



TWIST SATIN



ROUND POLISHED



SQUARE POLISHED



FLAT ROUND POLISHED



TWIST POLISHED



* ROUND BLACK



* SQUARE BLACK

Door Pull



ROUND POLISHED



ROUND SATIN



* ROUND BLACK



SQUARE POLISHED



SQUARE SATIN



* SQUARE BLACK

* Optional Upgrades

Lock Types for Pivot Doors with handles

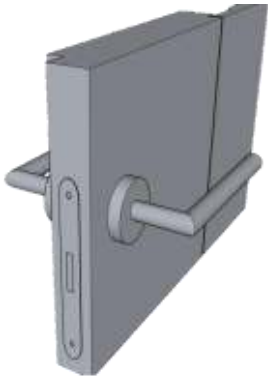

Passage
Magnetic (PA)

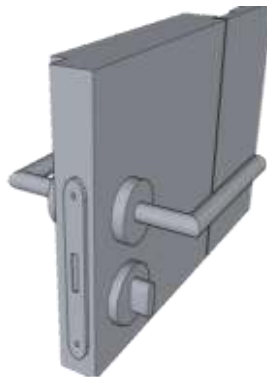

Privacy
Magnetic (PV)

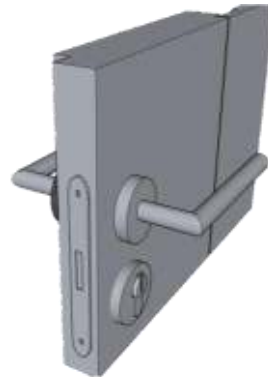

Keyed
Magnetic



* Knife pull +
Magnet catch
(Outswing doors only)

Lock Types for Pivot Doors with pulls

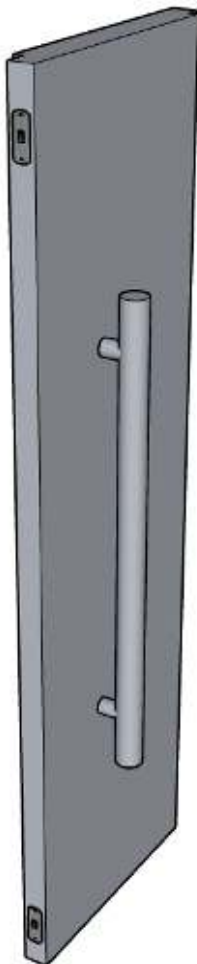

Door Pull +
Magnet Catch +

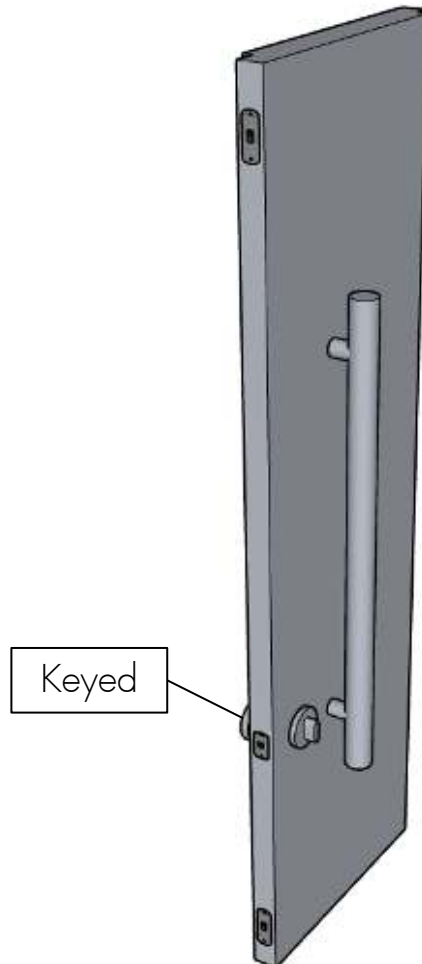

Door Pull +
Magnet Catch + Dead Bolt