

Filo muro/ frameless, flush to the wall

SWING DOOR



Types of Applications



Finishes

- Primed / Laminated Import
- Laminated Suncrest / Matte Lacquer
- Wood veneer

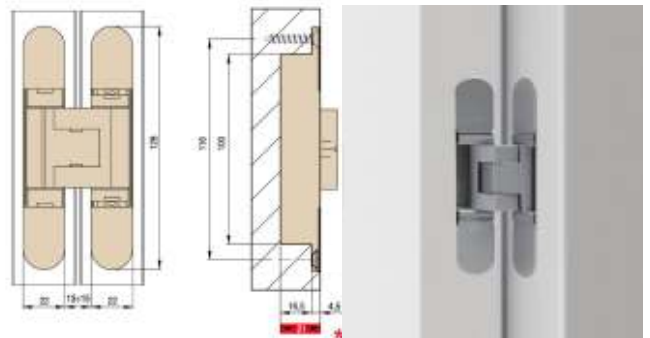

What's included

- Technical Specifications:
- Solid Core Door Slab
- Finish – Designer's choice
- Hinges – CEAM Italia 3D adjustable
- Frame – Concealed aluminum
- Handset – DAYORIS Italia
- Mortise – Bonaiti Magnetic
- Design – Designers Choice

Frame Profile Finishes

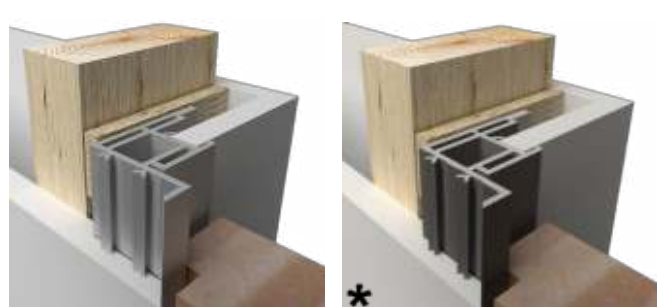

Clear Aluminum Frame

* Black Aluminum Frame

* Optional Upgrades

Benefits of Filo muro/ frameless, flush to the wall

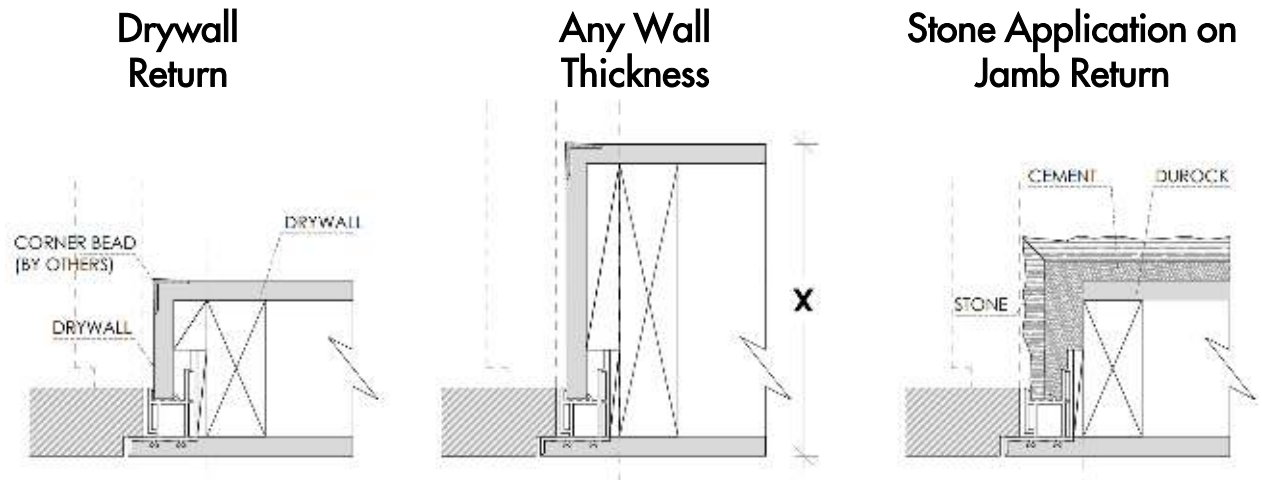

Always flush on the outside of the wall regardless of the door swing.

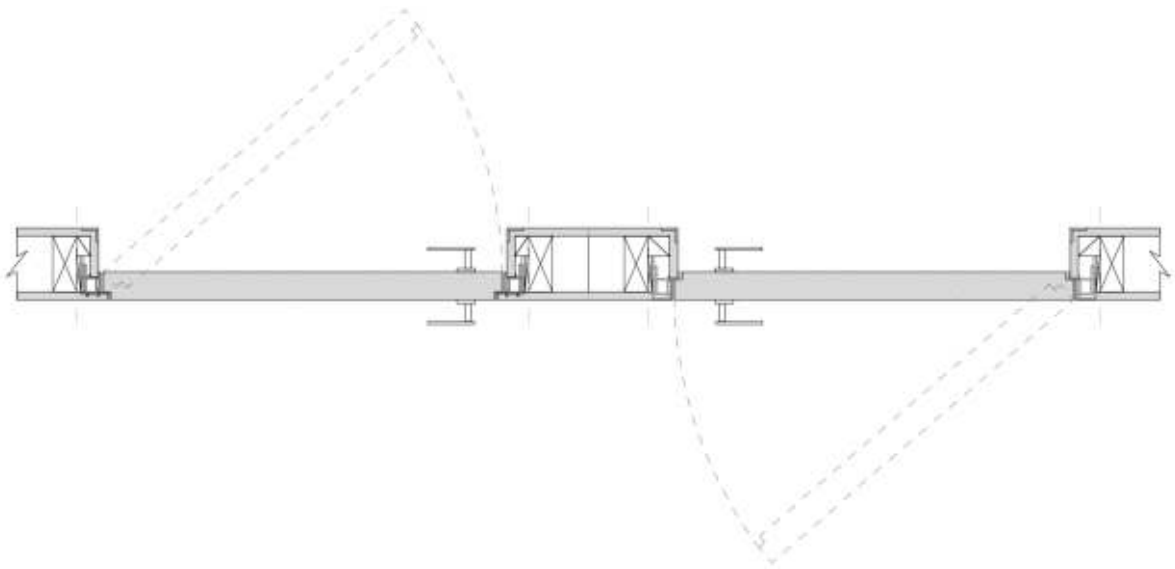

Works with 1/2" depth reglet (any height). Can be used with 5/8" drywall.

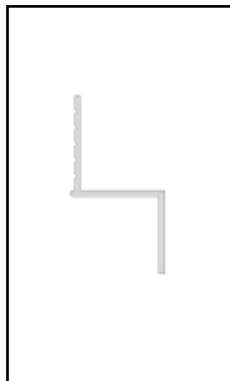

DEPTH	WIDTH	NON-VENTED
1/2"	1/8"	DRMZ-25-125
1/2"	1/4"	DRMZ-50-25
1/2"	3/8"	DRMZ-50-375
1/2"	1/2"	DRMZ-50-50
1/2"	5/8"	DRMZ-50-625
1/2"	3/4"	DRMZ-50-75
1/2"	1"	DRMZ-50-100
1/2"	1 1/2"	DRMZ-50-150
1/2"	2"	DRMZ-50-200

* Fry reglet for reference purposes only, not provided by Dayoris.

Framing Instructions Filo muro/ frameless, flush to the wall

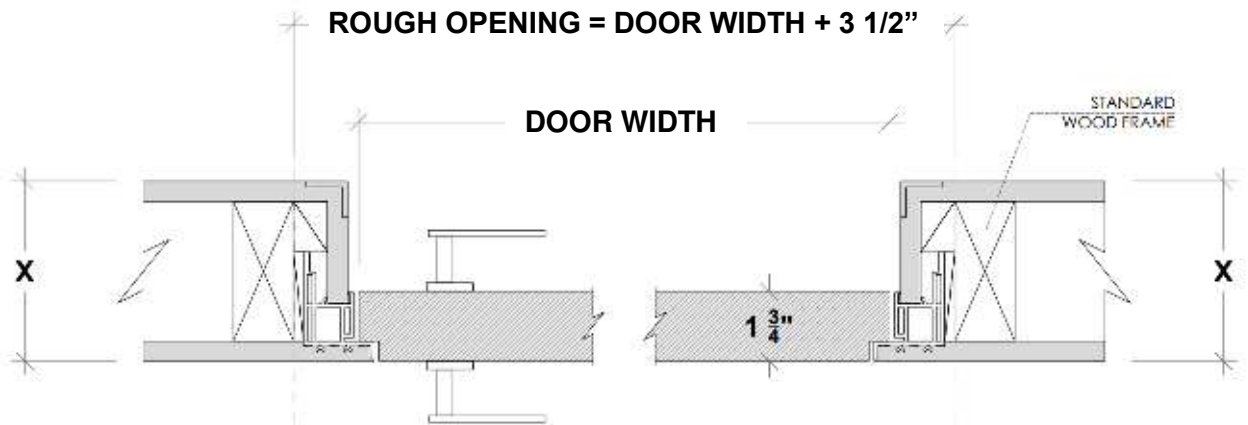

$X =$ THE WALL CAN BE ANY THICKNESS
 ALL OPENINGS MUST HAVE WOOD SUPPORT ($2" \times 4"$, $2" \times 6"$, $2" \times 8"$, ...)

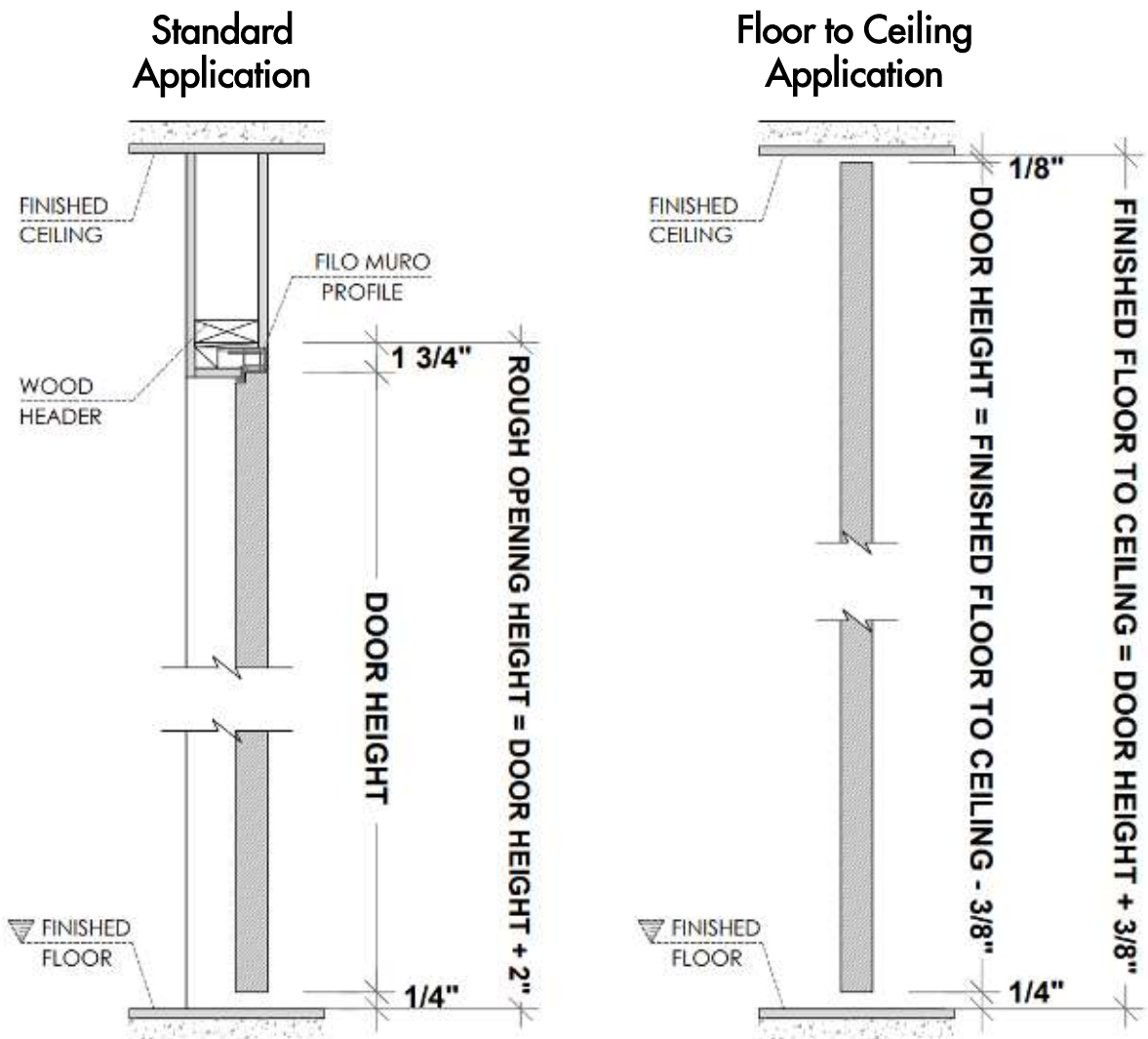

PLEASE ACCOUNT FOR FINISHED FLOOR FOR ALL MEASUREMENTS GIVEN TO DAYORIS.

Inswing Application

Left Hand Inswing

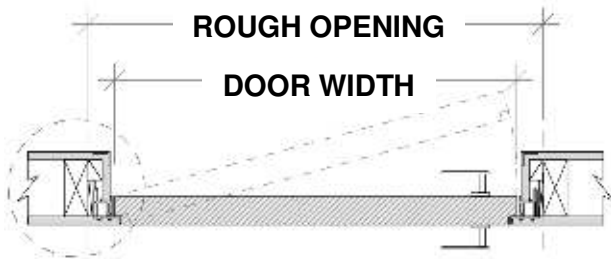

Right Hand Inswing

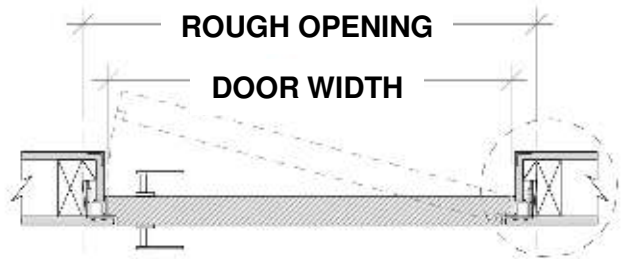

CORNER BEAD
(BY OTHERS)

SHIM SPACE

DRYWALL AND PLASTER
(BY OTHERS)

DAYORIS
DOOR SLAB

DAYORIS
FILO MURO
PROFILE

$\frac{7''}{8}$

MESH TAPE
MUD/PLASTER
(BY OTHERS)

FLOOR TRANSITION
 $\frac{7''}{8}$ FROM DRYWALL

45° BEVEL FOR
PLASTER FINISH

Outswing Application

Right Hand Outswing

Left Hand Outswing

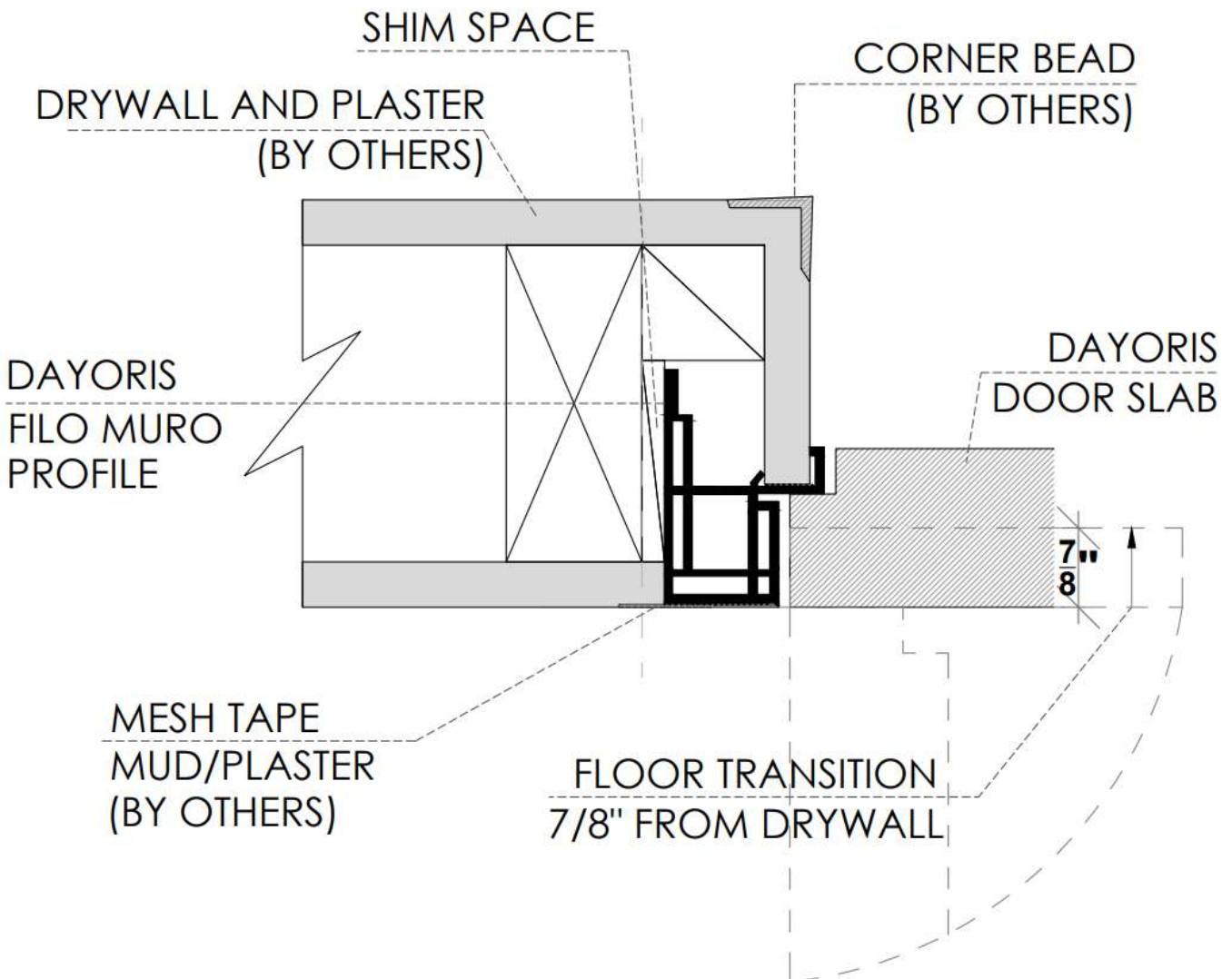
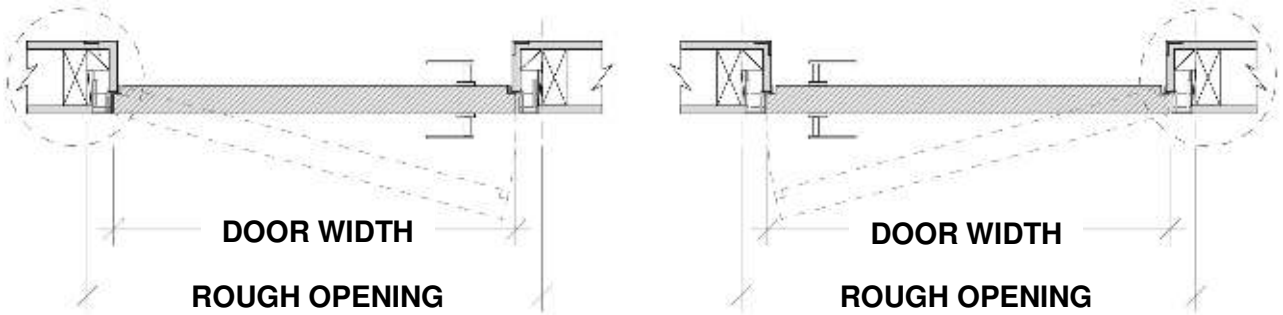

Double Door Applications

Double Dummy Application with top magnetic catch (both active)

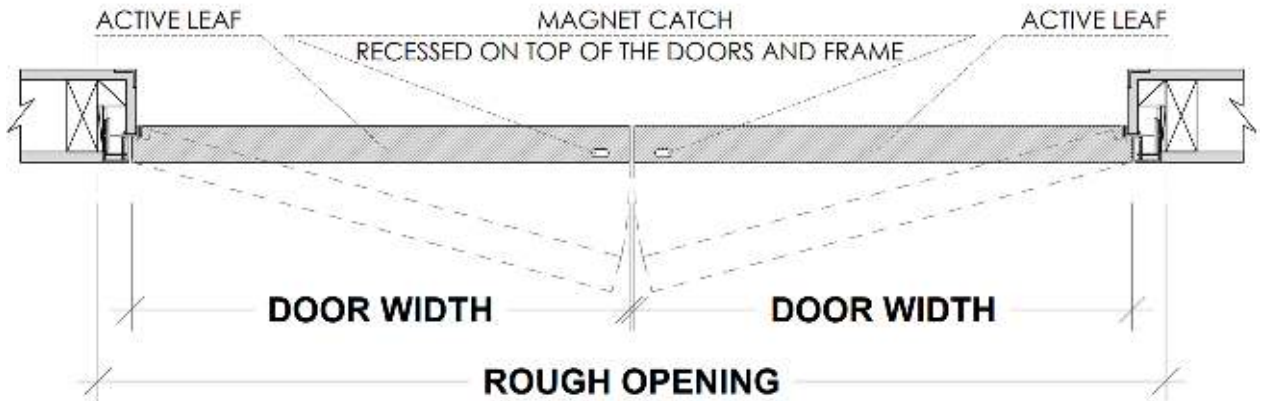

$$\text{ROUGH OPENING} = (\text{DOOR WIDTH} \times 2) + 3 \frac{1}{2}"$$

Active / Inactive Door with flush bolts

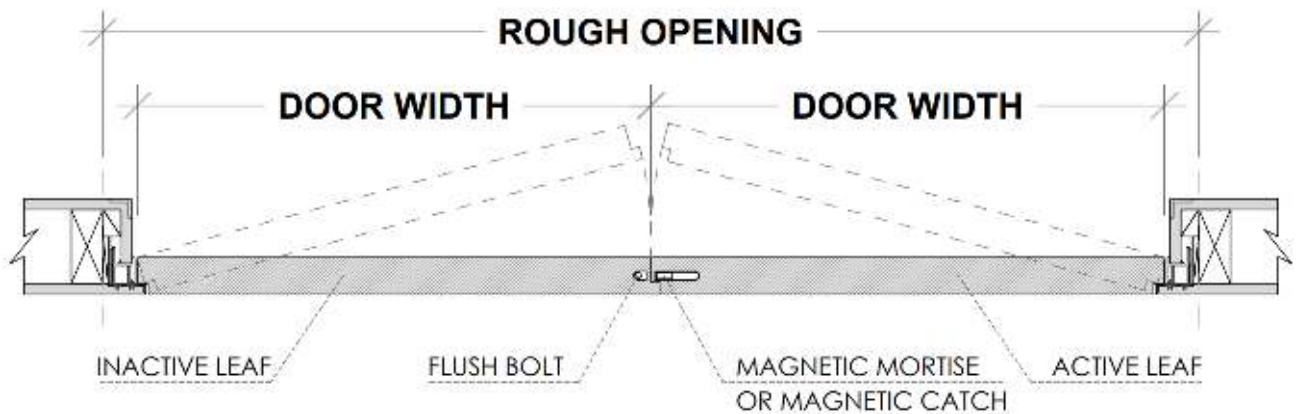

RHA (RIGHT HAND ACTIVE) SHOWN

$$\text{ROUGH OPENING} = (\text{DOOR WIDTH} \times 2) + 3 \frac{1}{2}"$$

Filo muro with Transom Application

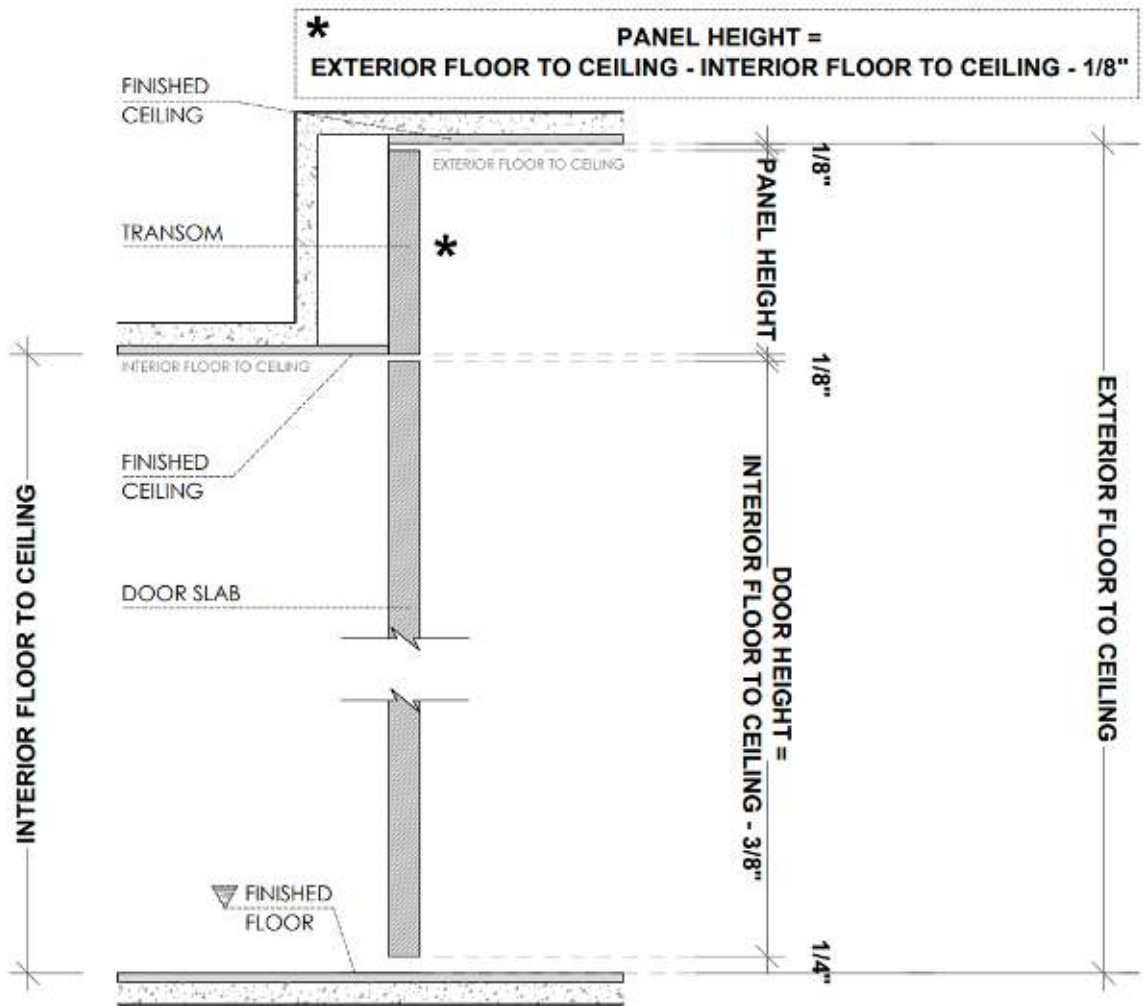

Hardware



Lock Types for Swing Doors

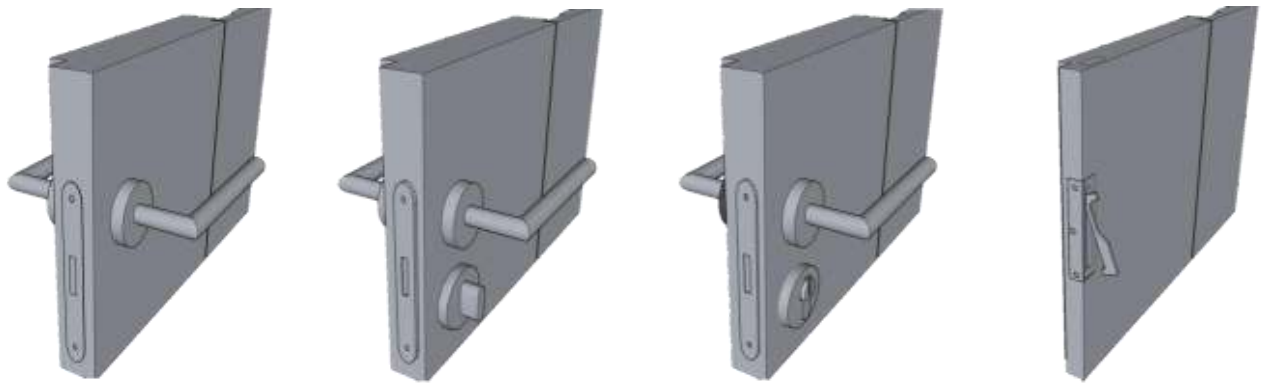

Passage (PA)

Privacy (PV)

Privacy Keyed *

Knife pull + Magnet catch

Bonaiti Magnetic Lock

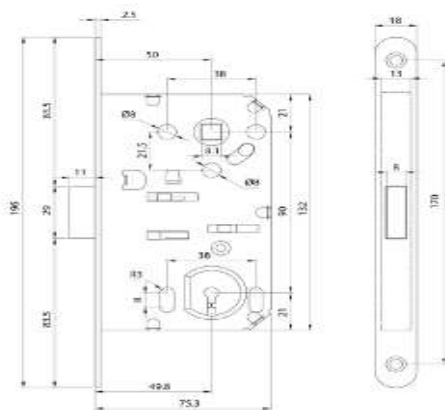

* Optional Upgrades

Filo muro/ frameless, flush to the wall

Installation Instructions

Doors and frames arrive mortised and cut to size.



Verify the level of the wall and rough openings

Identify the furthest point out of level of the wall. (This is where the door is installed).



Installing the aluminum frame

Place and screw wood shims leveling the aluminum frame inside 2'x4' rough, then remove frame stabilizers.

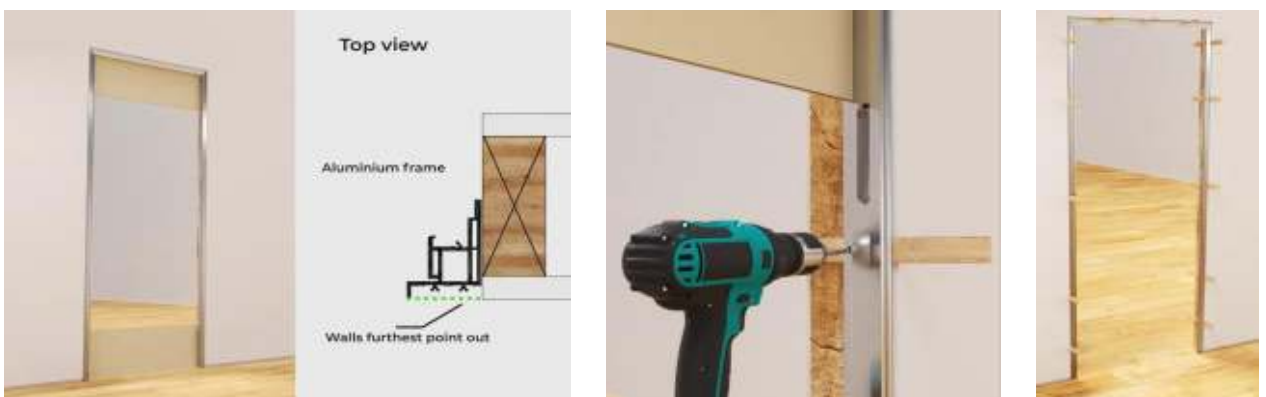

Filo muro/ frameless, flush to the wall

Hinge installation

Fit and screw hinges into the frame and door, then connect and screw hinges together while hanging door inside the aluminum frame. Use hinge adjustment screws to center door inside of the aluminum frame.

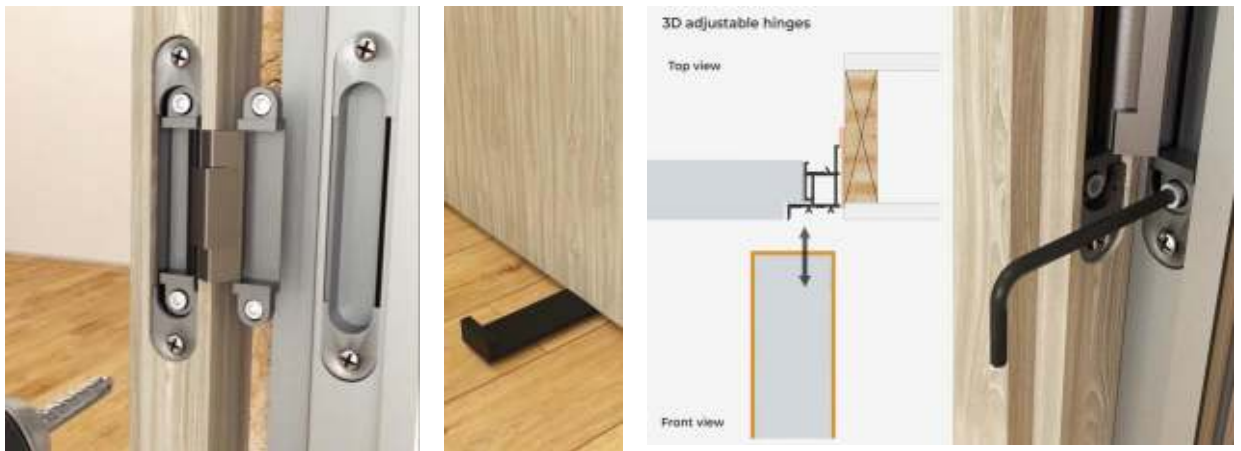

Handle installation

Screw handles into the mortised holes of the door and install rosettes. Proceed to cut the wood shims around the frame.

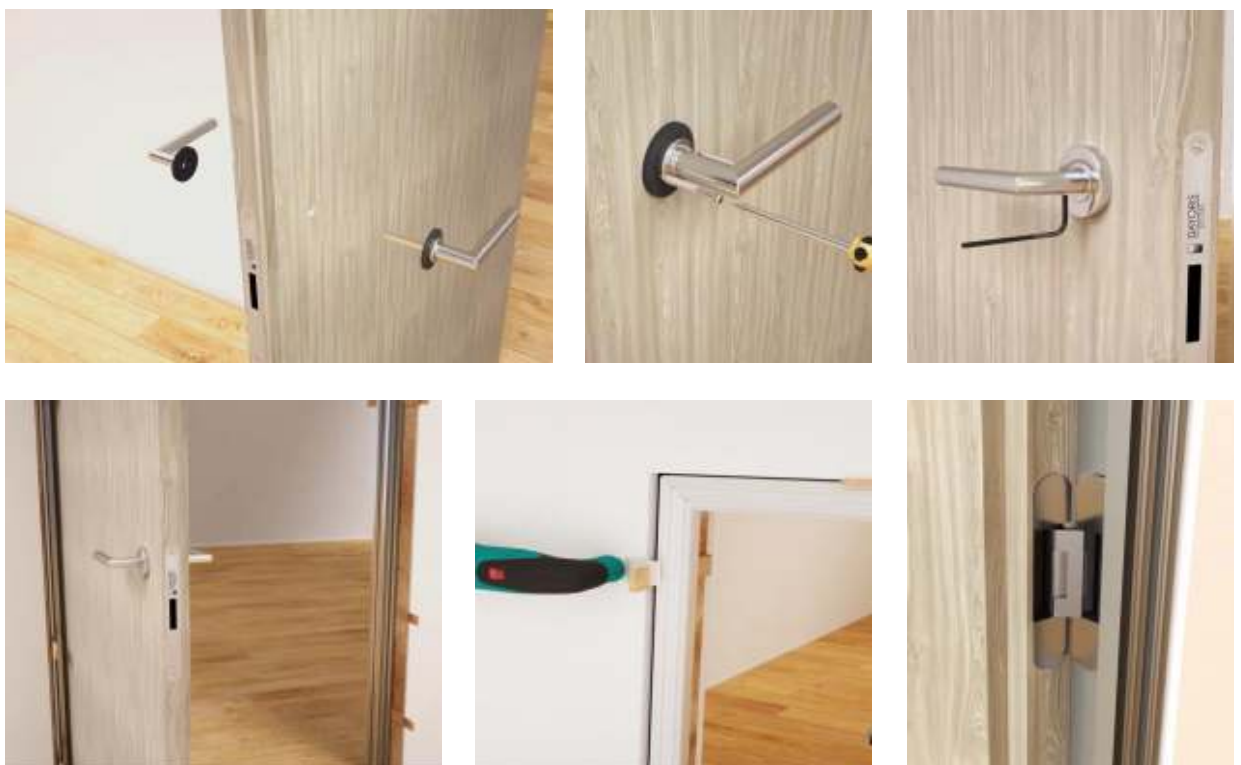

Filo muro/ frameless, flush to the wall

Finishing Technique

Flush to the wall

Front side: Use mesh tape to cover transition between 2'x4' and aluminum frame. Then apply plaster over mesh tape up to the 45° bevel in aluminum frame.



Rear side: Plaster application fits any wall thickness. Insert corner bead at transition point for a proper finish.



Tile or stone application: Plaster flush side as described above. Apply stone on jamb insert joining adjacent wall.

